



Fowler®

HIGH PRECISION

TOOL-A-THON®



over
30 NEW
items!



Volume 21.1

Valid Jan. 1st - Apr. 30th

www.fowlerprecision.com

NEW PRODUCTS!



Check out the scannable QR codes for product details and videos!

SCAN S25T

Page 4 • Tabletop part scanning



SCAN F60T

Page 4 • Large part thread scanning

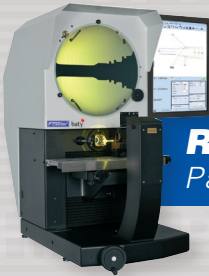

A-Line A4 Portable Arm

Page 5 • Portable, 6 axis measuring



R400FT2-E Optical Comparator

Page 5 • High accuracy non-contact measuring

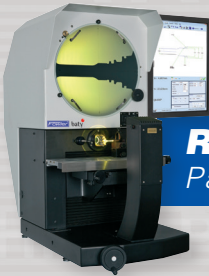

Quadra Check

Page 8 • Bluetooth Test Indicators



Mini S Dial Indicators

Page 8 • Bluetooth, small sized

Hi_Cals Height Gages

Pages 10-11 • NOW with Bluetooth



NEW PRODUCTS!



Check out the scannable QR codes for product details and videos!

Roto Dial Holder

Page 44 • 360° Indicator positioning



Xtra-Height PLUS

Page 46 • Economical dimensional measuring



Xtra-Mag Height PLUS

Page 47 • Limited space height gage

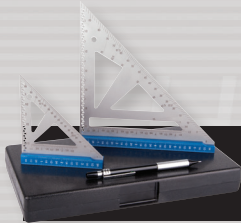

Xtra-Tri PLUS Square Set

Page 51 • Layout and measuring squares

Space X-BLOX PLUS Sets

Page 51 • Work set-up sets



Quill Set

Page 52 • Machine tool adapter



Weight & Counting Scale

Page 55 • 66 lb. capacity

Fowler Sylvac **SCAN S25T**

Fast, Accurate, Reliable & Repeatable!



Features:

- **NEW** bench top size
- 30° tilting for complete thread measurements
- High accuracy, easy to use
- One-click measuring
- Capacity: 2"/50mm diameter, 8"/200mm length

The measuring solution for turned parts!



SCAN For More Info



Order No. 54-902-025-5

Use Promo Code 21.1S25T
when purchasing to claim your Sylvac Bluetooth Caliper and Bluetooth Micrometer. **Over \$1,100 Value!**

Fowler Sylvac **SCAN F60T**



Features:

- Complete 2D part scan in less than 3 seconds
- 30° tilting for complete thread measurements
- Reduce inspection time
- High accuracy, easy to use
- One-click measuring
- Range: 2.3"/60mm diameter, 12"/300mm length

Exclusive helix tilting system for more comprehensive thread measurements



See it in ACTION!



Order No. 54-902-406-5

Use Promo Code 21.1F60T
when purchasing to claim your Sylvac Bluetooth Caliper and Bluetooth Micrometer. **Over \$1,100 Value!**

Fowler Trimos A-Line Portable Measuring Arms

Features:

- Portable, take measurements right in the machines center
- Used for inspection, aerospace, automotive applications
- Utilizes Fowler FUSION software
- Easy to use
- Up to 6-axis configuration
- Many probe options available



See it in ACTION!



Inspection



Automotive

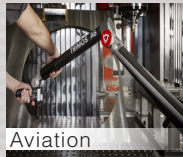

Aviation



Aerospace



**SWISS
MADE**

Fowler FUSION
Metrology Software

Order No.	Model	Range	Volumetric Accuracy
54-960-010-0	A-4	70"/1800mm	0.0009"/0.025mm
54-960-011-0	A-4	98"/2500mm	0.0014"/0.036mm

Additional Models Available

Use Promo Code 21.1A4

when purchasing to claim your Sylvac Bluetooth Caliper and Bluetooth Micrometer. **Over \$1,100 Value!**

Fowler Baty R400FT2-E Optical Comparator

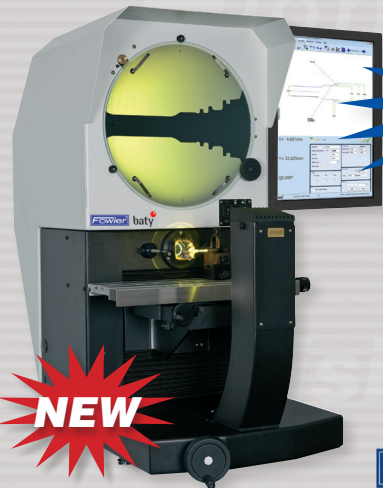

20% off
List pricing

See it in ACTION!



Features:

- 16"/400mm screen
- Optical Edge Sensor combined with Fowler FUSION software makes for the most functional, user-friendly comparator out on the market
- Additional accessories available

**Lenses purchased separately*

Fowler FUSION
Metrology Software



Order No. 53-900-900-0

Sale \$19,064.⁰⁰

List \$23,830.00

Prices & Specifications are subject to change without notice.



Fowler Ultra-Cal VI Electronic Calipers



54-100-167-0

Features:

- Swiss accuracy
- IP67 protected against fluid and dust
- Available with or without Bluetooth
- Heavy duty frame
- Extra large display
- NOW available with ISO Cert
- 12"/300mm is supplied without depth rod



LIFETIME WARRANTY

SWISS PRECISION



IoT READY

Learn more at ...
YouTube
FowlerVid

Calibration certificates available for all sizes

Order No.	Range	Accuracy	Resolution	List Price	Sale Price
Without Data Output					
54-100-177-0	6"/150mm	0.0008"/20µm	0.0005"/0.01mm	\$172.73	\$164.09
54-100-178-0	8"/200mm	0.0012"/30µm	0.0005"/0.01mm	\$354.55	\$336.82
54-100-179-0	12"/300mm	0.0012"/30µm	0.0005"/0.01mm	\$468.11	\$444.70
Bluetooth Models					
54-100-167-0	6"/150mm	0.0008"/20µm	0.0005"/0.01mm	\$398.37	\$378.45
54-100-168-0	8"/200mm	0.0012"/30µm	0.0005"/0.01mm	\$645.90	\$613.61
54-100-169-0	12"/300mm	0.0012"/30µm	0.0005"/0.01mm	\$860.60	\$817.57
Accessory					
54-115-246-BT	USB bluetooth receiver			\$50.80	\$45.80

Fowler Ultra-Cal VI Proximity Electronic Calipers



54-100-444-1

Features:

- Swiss accuracy
- IP67 protected against fluid and dust
- Ultra-Cal VI technology with proximity cable data output
- Heavy duty frame
- Extra large display
- 12"/300mm is supplied without depth rod

LIFETIME WARRANTY

SWISS PRECISION



Order No.	Range	Accuracy	Resolution	List Price	Sale Price
54-100-444-1	6"/150mm	0.0008"/20µm	0.0005"/0.01mm	\$188.99	\$179.54
54-100-448-1	8"/200mm	0.0012"/30µm	0.0005"/0.01mm	\$390.91	\$371.36
54-100-412-1	12"/300mm	0.0012"/30µm	0.0005"/0.01mm	\$527.27	\$500.91
Connectivity Cables					
54-115-526-0	Proximity cable with USB connection			\$198.87	\$135.00
54-155-527-0	Proximity cable with serial connection			\$202.69	\$135.00

Fowler Rapid-Mic Quick-Displacement Electronic Micrometers

21.1



SWISS Hand Tools



**WORLD'S FINEST
Micrometer!**

"I have been in the machining business for over 30 years this is by far the best mic I have ever had. One little thing or should I rephrase that, one huge thing, this mic comes with a lifetime warranty, no other company can provide that!"

John T.

Features:

- Fastest micrometer on the market
- IP67 protected against fluid and dust
- Position recall
- Adjustable measuring force, 5N/10N (54-815-030-0 only)
- Menu customizable with free software
- Non-rotating spindle with 10mm travel per thimble rotation
- USB output or Bluetooth available

LIFETIME WARRANTY



Watch the Demo!
You Tube
FowlerVid

SWISS MADE



IoT READY



54-815-111-0

Calibration certificates available for all sizes

Order No.	Range	Accuracy	List Price	Sale Price
54-815-030-0	0 - 1.18"/0 - 30mm	0.00012"/0.003mm	Compare to Mitutoyo 293-676-20 @ \$560.00	\$513.95
54-815-060-0	1.18" - 2.6"/30 - 66mm	0.00016"/0.004mm	\$990.15	\$959.15
54-815-100-0	2.6" - 4.0"/66 - 102mm	0.00020"/0.005mm	\$1,159.81	\$1,224.37
Set				
54-815-111-0	0 - 4"/0 - 102mm		\$2,820.47	\$2,679.45
Bluetooth Models				
54-815-130-0	0 - 1.18"/0 - 30mm	0.00012"/0.003mm	\$924.22	\$878.01
54-815-160-0	1.18" - 2.6"/30 - 66mm	0.00016"/0.004mm	\$1,214.24	\$1,153.53
54-815-110-0	2.6" - 4.0"/66 - 102mm	0.00020"/0.005mm	\$1,438.52	\$1,366.59
Bluetooth Set				
54-815-112-0	0 - 4"/0 - 102mm		\$3,526.07	\$3,349.77
Connectivity Cables/Accessory				
54-115-526-0	Proximity cable with USB connection		\$198.87	\$135.00
54-115-527-0	Proximity cable with serial connection		\$202.69	\$135.00
54-115-246-BT	USB Bluetooth receiver		\$50.80	\$45.80

Prices & Specifications are subject to change without notice.



Fowler **QuadraTest**TM

Multimode Electronic Test Indicators

The Fowler QuadraTest is the perfect solution for test indicating applications

Features:

- Bluetooth connectivity to your phone or tablet
- IP65 protected against fluid and dust
- 4 measuring modes: Min, Max, TIR and Direct
- 4 measuring resolutions - 0.00005"/0.001mm or 0.0005"/0.01mm
- 1-1/2" diameter dial face rotates a full 360°
- Analog scale for reversal point indication
- Meets or exceeds DIN/ISO Standards (Maximum error on .00005" scale at full range: 0.0004")
- **54-562-890-BT is capable of interchanging contact point lengths**

54-562-777-BT



SWISS MADE



Protected to
IP65
DUST & LIQUID RESISTANT

IOT READY

Order No.	Range	Contact Point Length	List Price	Sale Price
54-562-777-BT	0.030"/0.80mm	1/2"	\$585.00	\$526.50
54-562-888-BT	0.080"/2.0mm	1-7/16"	\$648.00	\$583.20
54-562-890-BT	0.030"/0.80mm 0.080"/2.0mm	1/2" 1-7/16"	\$740.00	\$666.00
Accessory				
54-115-528-0	Output Cable USB		\$319.85	\$303.86

Fowler Mini S_Dial Indicators

Small in size **BIG** in features!

Features:

- All indicators features 0.50"/12.5mm range
- Bluetooth connectivity to your phone or tablet
- IP67 protected against fluid and dust
- Analog scale for reversal point indication
- 3/8" mounting diameter with 4-48 contact thread
- Auto power off feature
- Optional cable connectivity output

SWISS MADE



IOT READY

54-520-687-BT



54-520-692-0



Order No.	Accuracy	Resolution	List Price	Sale Price
Bluetooth Models				
54-520-687-BT	0.0004"/0.01mm	0.0005"/0.01mm	\$670.00	\$603.00
54-520-690-BT	0.0002"/0.005mm	0.00005"/0.001mm	\$880.00	\$792.00
Basic Models				
54-520-691-0	0.0004"/0.01mm	0.0005"/0.01mm	\$500.00	\$450.00
54-520-692-0	0.0002"/0.005mm	0.00005"/0.001mm	\$700.00	\$630.00
Accessory				
54-115-528-0	Output Cable USB		\$319.85	\$303.86

LIFETIME WARRANTY

We are so confident that these Fowler Sylvac Mark VI electronic indicators are the most accurate, most dependable, best made products you can buy, we are extending the warranty to last a LIFETIME!

*NO Gimmicks
NO Hurdles
NO Nonsense*

Quality, accuracy, dependability, world-class customer service and now a real LIFETIME WARRANTY!

Fowler Mark VI Electronic Indicators

Features:

- IP54 protected against fluid and dust
- Repeatability: 2µm
- Output: Proximity/Power - USB/RS232/digimatic/Wireless
- Menus customizable with free software
- Wide range of functions (MIN/MAX/DELTA, TOL, Factor, Preset. Auto Off, etc)
- Bezel rotates 270°
- Large display with LED tolerance indicators
- Includes lug back



This Button is programmable for common functions

54-530-135-0

54-530-335-0



Calibration certificates available for all sizes

Order No.	Range	Accuracy	Resolution	List Price	Sale Price
Low Resolution					
54-530-125-0	0 - 0.500"/12.5mm	0.0004"/0.01mm	0.0005"/0.01mm	\$631.02	\$567.92
54-530-145-0	0 - 1"/25mm	0.0004"/0.01mm	0.0005"/0.01mm	\$720.26	\$648.23
High Resolution					
54-530-135-0	0 - 0.500"/12.5mm	0.00012"/0.003mm	0.00005"/0.001mm	\$780.81	\$702.73
54-530-155-0	0 - 1"/25mm	0.00016"/0.004mm	0.00005"/0.001mm	\$854.11	\$768.70
54-530-175-0	0 - 2"/50mm	0.00019"/0.005mm	0.00005"/0.001mm	\$1,497.88	\$1,348.09
Bluetooth					
54-530-335-0	0 - 0.500"/12.5mm	0.00012"/0.003mm	0.00005"/0.001mm	\$987.96	\$889.17
54-530-355-0	0 - 1"/25mm	0.00016"/0.004mm	0.00005"/0.001mm	\$1,054.89	\$949.40
NANO with Bluetooth					
54-530-635-0	0 - 0.500"/12.5mm	0.00007"/0.0018mm	0.00001"/0.0001mm	\$1,302.70	\$1,172.43
54-530-640-0	0 - 1"/25mm	0.00008"/0.0022mm	0.00001"/0.0001mm	\$1,564.17	\$1,407.75
Accessory					
54-115-246-BT	USB Bluetooth Receiver			\$50.80	\$45.80





Fowler Sylvac **BLUETOOTH** Hi_Cal Electronic Height Gages

Features:

- **Quick, easy computer recorded measurements**
- Extra low measuring force, from 0.2N
- Measure internal and external diameters, centerlines, heights, widths, depths and MIN/MAX/TIR capability
- Excellent repeatability thanks to the motorized carriage
- High reliability
- Bluetooth, USB and RS232 data outputs
- Battery life: 40 hours rechargeable during operation
- Touch sensitive probe speed for easy operation
- Base with small footprint
- Includes: protective cover, charging set, ruby ball probe Ø3mm, setting gage and calibration certificate



54-931-150-BT

FREE 1mm Ball Probe
with 6"/150mm and 12"/300mm Hi_Cal Purchase!



54-930-217-0



FREE Basic Probe Set
with 54-931-450-BT Hi_Cal Purchase \$675.00 Value!

Accessory Probe Sets



54-930-215-0

Watch the Demo!
YouTube
FowlerVid

Order No.	Range	Accuracy	List Price	Sale Price
54-931-150-BT	6"/150mm	0.00013"/0.0034mm	\$5,698.25	\$5,128.43
54-931-150-BT-C	6"/150mm <i>with ISO/A2LA Certification</i>			\$5,378.43
54-931-300-BT	12"/300mm	0.00016"/0.0042mm	\$6,219.85	\$5,597.87
54-931-300-BT-C	12"/300mm <i>with ISO/A2LA Certification</i>			\$5,947.87
54-931-450-BT	17.5"/450mm	0.00020"/0.005mm	\$7,080.10	\$6,372.09
54-931-450-BT-C	17.5"/450mm <i>with ISO/A2LA Certification</i>			\$6,722.09
Accessories				
54-930-215-0	Full Probe Accessory Set		\$1,659.78	\$1,215.00
54-930-217-0	Basic Probe Accessory Set		\$940.80	\$675.00



54-931-300-BT



See it in ACTION!



54-931-450-BT



Contact the Fowler Sales Department
1-800-788-2353

V-Series Special Pricing!

Fowler Trimos V3, V4 & V5 Electronic Height Gages

The Fowler Trimos V3, V4 and V5 vertical measuring instruments have been developed for the most difficult workshop environments. Manufactured in Switzerland, they guarantee a robust, precise and reliable product.

Features:

- "Black Mask" display with user friendly functions
- Electronically adjustable measuring force 0.75/1.5 (N)
- Lithium-ion rechargeable batteries last up to 40 hours
- All adjustments possible without tools
- Cast iron base for optimal stability and rigidity
- RS232 and USB interfaces requires 54-192-112-0 cable. Bluetooth transmitter also available
- Dual probe holders (V4 - V9)
- Carriage displacement: Manual for V3 and V4 models
V5 - V9 includes selectable manual or motorized carriage displacement
- Measures heights, diameters, perpendicularity, centerlines, Min/Max/Delta
- Resolution: 0.00005"/0.001mm
- Repeatability (2s): 0.00008"/0.002mm (Ø 0.00016"/0.004mm)

All models include:

- Charging unit
- Measuring insert with ruby ball Ø4mm
- Probe holder elbow Ø 8mm
- Setting gage
- User's manual and test certificate

***Height Gages available up to 40", 60", 80" upon request**

V3	54-192-340-0	54-192-370-0
Measuring Range	16"/407mm	28"/711mm
Range with Probe inverted	20"/508mm	31.9"/812mm
Max. Permissible Errors	0.00028"/0.007mm	0.00032"/0.008mm
Frontal Squareness Deviation	0.0004"/0.010mm	0.0006"/0.015mm
Air Cushion		NO
V4	54-191-440-0	54-191-470-0
Measuring Range	16"/407mm	28"/711mm
Range with Probe inverted	28.3"/719mm	40.2"/1023mm
Max. Permissible Errors	0.0002"/0.005mm	0.00028"/0.007mm
Frontal Squareness Deviation	0.0004"/0.010mm	0.0006"/0.015mm
Air Cushion		YES
V5	54-199-540-0	54-199-570-0
Measuring Range	16"/407mm	28"/711mm
Range with Probe inverted	28.3"/719mm	40.2"/1023mm
Max. Permissible Errors (µm)	2.5 + L(mm)/300	
Frontal Squareness Deviation	0.0002"/0.005mm 0.00032"/0.008mm	
Air Cushion		YES



See it in
ACTION!



Order No.	Description	Range	List Price	Sale Price
54-192-340-0	V3 Height Gage	16"/407mm	\$4,730.41	\$4,129.65
54-192-370-0	V3 Height Gage	28"/711mm	\$5,215.46	\$4,553.10
54-191-440-0	V4 Height Gage	16"/407mm	\$6,231.03	\$5,439.69
54-191-470-0	V4 Height Gage	28"/711mm	\$7,248.66	\$6,328.08
54-199-540-0	V5 Height Gage	16"/407mm	\$6,867.42	\$5,995.26
54-199-570-0	V5 Height Gage	28"/711mm	\$8,138.14	\$7,104.60
Probe Sets				
54-199-105-0	4mm Probe Set, 21 piece		\$1,819.90	\$1,588.77
54-199-106-0	8mm Probe Set, 16 piece		\$1,358.04	\$1,200.00
54-199-107-0	Economy Probe Set, 7 piece		\$482.16	\$450.00
Accessories				
54-199-400-0	12"/300mm Holder - for 8mm probes		\$1,018.76	\$889.38
54-199-022-BT	Bluetooth transmitter for (Not available for V3 models)		\$675.00	
54-777-120-0	Vmux software - for connecting multiple units to one PC		\$465.50	\$418.95

16"/407mm
\$4,129.⁶⁵

Order No: 54-192-340-0

16"/407mm
\$5,439.⁶⁹

Order No: 54-191-440-0



Measures ID/OD, centerlines,
heights, widths, depths,
min/max/delta, slots,
grooves and more!

NOW
available with ISO Cert

 Contact the Fowler Sales
Department 1-800-788-2353

28"/711mm
\$7,104.⁶⁰

Order No: 54-199-570-0

EXTREMELY Easy to Use!

Outside Inch Micrometers



52-240-001-1



52-215-003-1

Features:

- Microfine graduations on satin chrome finish and carbide tipped measuring faces
- Diameter of measuring faces: 0.256"
- Graduation: 0.0001"
- Flatness: 0.00003"
- Positive lever locking clamp
- Spindle thread hardened, ground and lapped for ultimate accuracy
- Anvil & spindle hardened and precision ground with microlap finish on tips
- Includes a wrench and case
- Sizes over 1"/25mm include a calibration standard

Order No.	Range	Accuracy	Thimble	List Price	Sale Price
52-240-001-1	0 - 1"	± 0.00016"	Friction	<i>Compare to Brown & Sharpe 00180070 @ \$118.00</i>	\$42.47
52-240-101-1	0 - 1"	± 0.00016"	Ratchet	\$47.19	\$42.47
52-240-002-1	1 - 2"	± 0.00016"	Friction	\$54.89	\$49.40
52-240-102-1	1 - 2"	± 0.00016"	Ratchet	\$54.89	\$49.40
52-240-003-1	2 - 3"	± 0.0002"	Ratchet	\$64.13	\$57.72
52-240-004-1	3 - 4"	± 0.0002"	Ratchet	\$71.61	\$64.45
52-240-005-1	4 - 5"	± 0.00024"	Ratchet	\$79.31	\$71.38
52-240-006-1	5 - 6"	± 0.00024"	Ratchet	\$86.90	\$78.21
52-240-007-1	6 - 7"	± 0.00028"	Ratchet	\$94.49	\$85.04
52-240-008-1	7 - 8"	± 0.00028"	Ratchet	\$111.21	\$100.09
52-240-009-1	8 - 9"	± 0.00032"	Ratchet	\$126.39	\$113.75
52-240-010-1	9 - 10"	± 0.00032"	Ratchet	\$143.33	\$129.00
52-240-011-1	10 - 11"	± 0.00036"	Ratchet	\$158.51	\$142.66
52-240-012-1	11 - 12"	± 0.00036"	Ratchet	\$173.69	\$156.32
Sets					
52-215-003-1	0 - 3" with standards and fitted shop hardened case			\$164.45	\$148.01
52-215-004-1	0 - 4" with standards and fitted shop hardened case			\$235.62	\$212.06
52-215-006-1	0 - 6" with standards and fitted wooden case			\$399.96	\$359.96
52-215-012-1	0 - 12" with standards and fitted wooden case			\$1,212.53	\$1,091.28
52-215-612-1	6 - 12" with standards and fitted wooden case			\$799.92	\$719.93

Large Capacity Inch Micrometers

Fowler's Large Capacity Inch Micrometers are used for larger applications and is available in sizes up to 20". Each micrometer offers superior design and workmanship to ensure high precision and long life at economical prices.



Features:

- Hammertone blue baked finish
- Microfine graduations on satin chrome finish and carbide tipped measuring faces
- Diameter of measuring faces: 0.295"
- Ratchet stop thimble for exact and repetitive readings
- Flatness: 0.00003"
- Quick, easy zero adjustment on sleeve
- Positive lever locking clamp ensures reliable measurement setting at all times
- Anvil & spindle hardened and precision ground with microlap finish on tips
- Includes a wrench and case
- All sizes include a calibration standard

Order No.	Range	Graduation	Accuracy	List Price	Sale Price
52-240-013-0	12 - 13" w/standards & case	0.001"	0.00044"	\$475.29	\$357.79
52-240-014-0	13 - 14" w/standards & case	0.001"	0.00044"	\$489.23	\$399.76
52-240-015-0	14 - 15" w/standards & case	0.001"	0.00044"	\$492.21	\$411.35
52-240-016-0	15 - 16" w/standards & case	0.001"	0.00044"	\$501.73	\$449.76
52-240-017-0	16 - 17" w/standards & case	0.001"	0.0005"	\$533.08	\$462.13
52-240-018-0	17 - 18" w/standards & case	0.001"	0.0005"	\$557.59	\$501.83
52-240-019-0	18 - 19" w/standards & case	0.001"	0.0005"	\$589.60	\$530.64
52-240-020-0	19 - 20" w/standards & case	0.001"	0.0005"	\$705.32	\$634.79

Outside Inch Micrometers

with Decimal Equivalents on Frame



Features:

- Black decimal equivalents on satin chrome finished forged steel frame
- Graduations: 0.0001"
- Ratchet thimble and locking nut
- Sizes over 1 1/2" / 25mm include a calibration standard

Order No.	Range	Accuracy	Thimble	List Price	Sale Price
52-235-001-1	0 - 1"	± 0.00016"	Ratchet	<i>Compare to Starrett T230RL @ \$204.30</i>	\$67.62
52-235-002-2	1 - 2"	± 0.00016"	Ratchet		\$78.21
52-235-003-2	2 - 3"	± 0.0002"	Ratchet	\$108.68	\$97.81
Set					
52-235-100-0	0 - 3"			\$237.40	\$213.66

Prices & Specifications are subject to change without notice.

Outside Inch Micrometers



52-253-001-1

**Tool-A-Thon
Special Pricing**

Features:

- Carbide tipped measuring faces
- Graduation: 0.001"
- Diameter of measuring faces: 0.256"
- Positive locking lever
- Anvil & spindle hardened and precision ground with microlap finish on tips
- Sizes over 1"/25mm include a calibration standard

Order No.	Range	Accuracy	Thimble	List Price	Sale Price
52-253-001-1	0 - 1"	± 0.001"	Friction	<i>Compare to Brown & Sharpe 599-1-44 @ \$103.00</i>	\$28.00
52-253-101-1	0 - 1"	± 0.001"	Ratchet	\$39.71	\$28.00
52-253-002-1	1 - 2"	± 0.001"	Friction	\$47.19	\$33.00
52-253-102-1	1 - 2"	± 0.001"	Ratchet	\$47.19	\$33.00
52-253-003-1	2 - 3"	± 0.001"	Ratchet	\$54.89	\$38.00
52-253-004-1	3 - 4"	± 0.001"	Ratchet	\$64.13	\$43.00
52-253-005-1	4 - 5"	± 0.001"	Ratchet	\$71.61	\$48.00
52-253-006-1	5 - 6"	± 0.001"	Ratchet	\$79.31	\$55.00

Outside Inch Micrometer Set

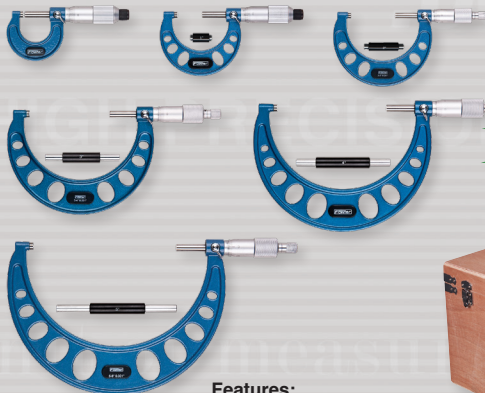

**Tool-A-Thon
Special Pricing**

Features:

- Range: 0 - 6"
- Carbide tipped measuring faces
- Graduation: 0.001"
- Diameter of measuring faces: 0.256"
- Positive locking lever
- Anvil & spindle hardened and precision ground with microlap finish on tips
- Sizes over 1"/25mm include a calibration standard



Order No. 52-253-600-1

Sale \$297.⁹⁰

List \$364.10

Digit Counter Micrometers



52-224-001-0



52-224-103-0

Features:

- Digital counter reads to 0.001"
- Resolution: 0.0001" (using vernier)
- Microfine graduations on satin chrome
- Carbide tipped measuring faces
- Positive locking nut on spindle
- Sizes over 1"/25mm include a calibration standard
- Includes case

Order No.	Range	Accuracy	List Price	Sale Price
52-224-001-0	0 - 1"	0.00016"	<i>Compare to Mitutoyo 193-211 @ \$144.00</i>	\$105.50
52-224-002-0	1 - 2"	0.00016"	\$135.41	\$98.50
52-224-003-0	2 - 3"	0.0002"	\$154.22	\$112.20
52-224-004-0	3 - 4"	0.0002"	\$169.73	\$123.50
52-224-005-0	4 - 5"	0.00024"	\$179.63	\$135.00
52-224-006-0	5 - 6"	0.00024"	\$187.77	\$141.00
Sets				
52-224-103-0	0 - 3" set		\$406.89	\$296.00
52-224-104-0	0 - 4" set		\$577.06	\$419.70
52-224-220-0	0 - 75mm set		\$428.45	\$311.60

Swiss-Style Micrometers



52-229-201-0



52-229-213-0

Features:

- 0.0001" reading
- Carbide measuring faces
- Insulated frame
- Ratchet thimble and locking lever
- Microfine graduations
- Sizes over 1"/25mm include a calibration standard
- Includes case

Order No.	Range	Accuracy	List Price	Sale Price
52-229-201-0	0 - 1"	± 0.00016"	\$61.05	\$49.00
52-229-202-0	1 - 2"	± 0.00016"	\$71.50	\$57.00
Sets				
52-229-213-0	0 - 3"	0 - 1", 1 - 2": ± 0.00016" 2 - 3": ± 0.0002"	\$220.11	\$170.00
52-229-214-0	0 - 4"	0 - 1", 1 - 2": ± 0.00016" 2 - 3", 3 - 4": ± 0.0002"	\$311.63	\$235.00



Micrometer Inspection Set

Fowler's setting master is quick, easy to use and extremely accurate. It comes with a certificate of calibration and a fitted aluminum case. Save time and money by calibrating your own measuring tools quickly and easily.

Set Includes:

- Stand height: 12.5"
- 9 pc. Grade AS-0 gage block set (sizes: 0.625", 0.100", 0.125", 0.200", 0.250", 0.300", 0.500", 1.000" & 2.000")
- Certificate of calibration is traceable to NIST standards & provides the individual deviation of each block
- Optical flat (flatness: .000004" ; Parallelism: 0.00002")
- 4.0mm ball end T-handle hex wrench



Use blocks you already have, get the holder alone!

Order No.	Description	List Price	Sale Price
53-813-001-2	Complete Checking Set	\$386.65	\$330.00
53-813-002-0	Mic Checker <i>without blocks</i>	\$193.82	\$165.00

Micrometer Stands



52-247-005-0

- Unique locking nut adjusts micrometer stand to any position for perfect use and viewing
- Stand folds for storage

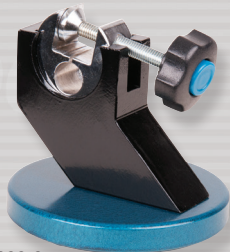

52-247-000-0

- Provides a measuring position and angle for outside micrometers and other instruments

XTRA MAG

52-247-010-0

- Holds standard 0-12" micrometers firmly to metal surfaces
- Use at machine centers, work, assembly and inspection stations, steel tables and shelves
- V-bottom for mounting on cylindrical surfaces
- On/Off magnet switch
- Base is 2.30" L x 1.20" W x 3.50" H



Micrometer
not included

Order No.	Description	List Price	Sale Price
52-247-000-0	Adjustable Micrometer Stand	\$67.10	\$48.80
52-247-005-0	Folding Micrometer Stand	\$44.99	\$32.80
52-247-010-0	Magnetic Micrometer Stand	\$79.59	\$63.00

XTRA-MIC[®] PLUS+ Electronic Micrometers



54-880-001-0



FREE!



Great for Shop Environments!

Features:

- IP54 protected against fluid and dust
- Corrosive resistant ratchet thimble (anodized aluminum)
- Super large LCD display, 14mm height
- Resolution: 0.00005"/0.001mm
- Carbide tipped anvil and spindle
- SPC output
- Sizes over 1"/25mm include a calibration standard
- Includes fitted case



54-880-103-0

Order No.	Range	Accuracy	List Price	Sale Price
54-880-001-0	0 - 1"/0 - 25mm	0.00016"/0.004mm	\$156.42	\$113.80
54-880-002-0	1 - 2"/25 - 50mm	0.00016"/0.004mm	\$180.29	\$131.20
54-880-003-0	2 - 3"/50 - 75mm	0.0002"/0.005mm	\$192.72	\$140.20
54-880-004-0	3 - 4"/75 - 100mm	0.0002"/0.005mm	\$220.99	\$160.80
Set				
54-880-103-0	0 - 3"/0 - 75mm		\$497.53	\$361.90
Accessory				
54-520-399-0	SPC cable		\$211.98	\$137.60

XTRA-VALUE[®] Digi-Micrometers



54-815-001-2

Features:

- IP54 protected against fluid and dust
- Rugged steel design
- Large LCD Display
- Absolute & incremental modes
- Automatic switch off
- Resolution: 0.00005"/0.001mm
- Carbide measuring faces
- Sizes over 1"/25mm include standard



Order No.	Range	Accuracy	List Price	Sale Price
54-815-001-2	0 - 1"/0 - 25mm	± 0.00016"	\$183.81	\$150.00
54-815-002-2	1 - 2"/25 - 50mm	± 0.00016"	\$213.18	\$175.00
54-815-003-2	2 - 3"/50 - 75mm	± 0.0002"	\$235.18	\$195.00
Set				
54-815-103-0	0 - 3"/0 - 75mm set		\$450.70	\$370.00

Prices & Specifications are subject to change without notice.

Electronic Coolant Resistant Micrometers



54-860-001-1

Absolute Reading!

FREE!

Ball Attachment

Features:

- IP54 protected against fluid and dust
- Automatic switch off
- Resolution: 0.00005"/0.001mm
- Carbide measuring faces
- Absolute & incremental modes
- Sizes over 1"/25mm include a calibration standard

Order No.	Range	Accuracy	List Price	Sale Price
54-860-001-1	0 - 1" ⁰ - 25mm	± 0.00016"/0.004mm	<i>Compare to INSIZE 3101-25E @ \$135.50</i>	\$114.30
54-860-002-1	1 - 2" ²⁵ - 50mm	± 0.00016"/0.004mm	\$161.70	\$117.60
54-860-003-1	2 - 3" ⁵⁰ - 75mm	± 0.0002"/0.005mm	\$176.33	\$128.30
54-860-004-1	3 - 4" ⁷⁵ - 100mm	± 0.0002"/0.005mm	\$204.71	\$148.90
54-860-005-1	4 - 5" ¹⁰⁰ - 125mm	± 0.00024"/0.006mm	\$229.24	\$167.00
54-860-006-1	5 - 6" ¹²⁵ - 150mm	± 0.00024"/0.006mm	\$257.29	\$187.00
Set				
54-860-103-1	0 - 3" ⁰ - 75mm Set		\$459.36	\$334.10

XTRA-VALUE II Electronic Micrometers



54-870-001-0

Absolute Reading!

FREE!

Ball Attachment

Features:

- IP40 protected against fluid and dust
- Resolution: 0.00005"/0.001mm
- Carbide measuring faces
- Absolute and incremental modes
- Ratchet thimble
- Sizes over 1"/25mm include a calibration standard

Order No.	Range	Accuracy	List Price	Sale Price
54-870-001-0	0 - 1" ⁰ - 25mm	± 0.00016"/0.004mm	\$110.20	\$80.20
54-870-002-0	1 - 2" ²⁵ - 50mm	± 0.00016"/0.004mm	\$119.02	\$86.60
54-870-003-0	2 - 3" ⁵⁰ - 75mm	± 0.0002"/0.005mm	\$134.86	\$98.10
54-870-004-0	3 - 4" ⁷⁵ - 100mm	± 0.0002"/0.005mm	\$150.81	\$109.70
Set				
54-870-103-0	0 - 3" ⁰ - 75mm		\$355.90	\$236.20

Point Anvil & Spindle Micrometers



Absolute Reading!

Features:

- IP54 protected against fluid and dust
- 30° pointed anvil and spindle for measuring small grooves, key-ways, small flutes, and hard to reach dimensions
- Large LCD Display, 8.5mm
- Automatic switch off
- Carbide measuring points
- Absolute & incremental modes
- Sizes over 1"/25mm include a calibration standard



Order No.	Range	Resolution	Accuracy	List Price	Sale Price
54-860-661-0	0 - 1"/0 - 25mm	0.00005"/0.001mm	0.00016"/0.004mm	\$205.26	\$150.00
54-860-662-0	1 - 2"/25 - 50mm	0.00005"/0.001mm	0.00016"/0.004mm	\$224.51	\$165.00
54-860-663-0	2 - 3"/50 - 75mm	0.00005"/0.001mm	0.0002"/0.005mm	\$251.13	\$185.00
54-860-664-0	3 - 4"/75 - 100mm	0.00005"/0.001mm	0.0002"/0.005mm	\$273.13	\$200.00

Electronic IP54 Ball Anvil Micrometers



Ball anvil and Flat spindle for measuring tubes or the insides of holes to outer edges



Ball anvil and Spindle for measuring special curved surfaces

Features:

- Protected to IP54 specifications
- Large LCD display, 8.5mm
- Automatic switch off
- Resolution: 0.00005"/0.001mm
- Hardened steel measuring face
- Absolute & incremental modes
- Sizes over 1"/25mm include a calibration standard

Absolute Reading!

Order No.	Range	Accuracy	List Price	Sale Price
Ball Anvil				
54-860-113-1	0 - 1"/0 - 25mm	0.00016"/0.004mm	\$141.57	\$105.00
54-860-114-1	1 - 2"/25 - 50mm	0.00016"/0.004mm	\$165.77	\$124.00
Ball Anvil & Spindle				
54-860-211-1	0 - 1"/0 - 25mm	0.00016"/0.004mm	\$154.22	\$115.00
54-860-212-1	1 - 2"/25 - 50mm	0.00016"/0.004mm	\$177.98	\$132.00

Prices & Specifications are subject to change without notice.



Vernier Thread Micrometers



52-219-001-1

Features:

- 60° measuring anvils
- Painted enamel and heat insulated frame
- Positive spindle lock
- Graduation: 0.001"
- Ratchet thimble
- Sizes over 1"/25mm include a calibration standard

Order No.	Range	Thread Range	Accuracy	List Price	Sale Price
52-219-001-1	0 - 1"	64 - 5 TPI/0.4 - 5mm	0.00016"	<i>Compare to Mitutoyo 126-137 @ \$412.94</i>	\$104.69
52-219-002-1	1 - 2"	44 - 3.5 TPI/0.6 - 7mm	0.00016"	\$130.97	\$115.25
52-219-003-1	2 - 3"	24 - 3.5 TPI/1 - 7mm	0.0002"	\$152.73	\$134.40
52-219-004-1	3 - 4"	24 - 3.5 TPI/1 - 7mm	0.0002"	\$165.39	\$145.54

Electronic IP65 Thread Micrometers



54-219-001-0

Features:

- IP65 protected against fluid and dust
- True inch/metric conversion
- 60° measuring anvils
- ABS/INC measuring mode
- Positive spindle lock
- Painted enamel and heat insulated frame
- Resolution: 0.00005"/0.001mm
- Friction thimble
- Sizes over 1"/25mm include a calibration standard



Order No.	Range	Thread Range	Accuracy	List Price	Sale Price
54-219-001-0	0 - 1"	64 - 5 TPI/0.4 - 5mm	± 0.00008"/0.002mm	\$297.88	\$262.13
54-219-002-0	1 - 2"	44 - 3.5 TPI/0.6 - 7mm	± 0.00008"/0.002mm	\$313.35	\$275.75
54-219-003-0	2 - 3"	24 - 3.5 TPI/1 - 7mm	± 0.00008"/0.002mm	\$318.20	\$280.02
54-219-004-0	3 - 4"	24 - 3.5 TPI/1 - 7mm	± 0.00012"/0.003mm	\$331.82	\$292.00

Telescoping Gage Sets

Another great tool for easy and accurate measurements. Under spring tension, the plungers of the gage expand from the center to the size of the hole being measured and are then locked in place using the knurled knob. Final hole size is obtained by measuring over the contacts with a micrometer or vernier caliper.

Features:

- Contact points are constructed of hardened tool steel, precision ground
- Double action rigid handle with self-centering feature for quick checking of inside measurements
- Constant spring tension for uniform feel
- **52-470-006-0 covers a measuring range of 5/16" to 6" with measurable depths of 4" to 5"**
- **52-470-007-0 covers a measuring range of 5/16" to 6" with measurable depths of 12"**

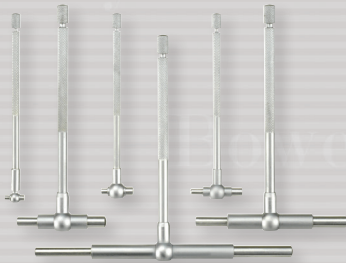

52-470-006-0

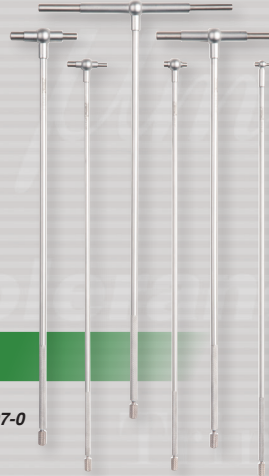

52-470-007-0

12" Reach!

Order No.	Description	List Price	Sale Price
52-470-006-0	6" Telescoping Gage Set	\$122.54	\$99.00
52-470-007-0	12" Telescoping Gage Set	\$147.51	\$110.00

Thread Measuring Wire Set

Features:

- **NOW includes wire holders**
- 48 wires in 16 different, 3 wire sets
- Accuracy for sizes 0.018" through 0.108" is within +0/-0.0004"
- Accuracy for sizes 0.120" through 0.185" is within +0/-0.0005"
- Measures all U.S. 60° threads from 3 - 48 threads per inch



Order No. 52-485-048-0

Sale \$31.00

List \$34.98

Premium Depth Micrometers

Features:

- Clear microfine graduations on satin chrome finish
- Base constructed of hardened tool steel is precision ground and microlapped. All other surfaces are satin chrome finished.
- Quick and easy zero adjustment
- Rods hardened, ground and lapped on measuring surfaces and adjustable in either direction
- Interchangeable rods are fitted to the micrometer spindle against a positive stop and locked
- Ratchet thimble
- Threads hardened, ground and lapped for accuracy
- Includes spanner wrench and fitted case



52-225-005-1

Order No.	Range	Graduation	Accuracy	Base Size	List Price	Sale Price
52-225-005-1	0 - 3"	0.001"	0.0002"	2.5"	\$182.82	\$146.26
52-225-006-1	0 - 4"	0.001"	0.0002"	2.5"	\$219.34	\$175.47
52-225-011-1	0 - 4"	0.001"	0.0002"	4"	\$223.36	\$175.47
52-225-015-1	0 - 6"	0.001"	0.0002"	4"	\$249.92	\$199.94
52-225-020-1	0 - 6"	0.001"	0.0002"	2.5"	\$240.79	\$192.63
52-225-035-1	0 - 12"	0.001"	0.00028"	4"	\$389.95	\$311.96

Economy Depth Micrometers

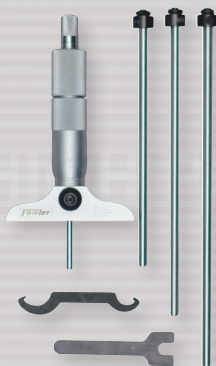

52-225-110-0

Features:

- Satin chrome finish
- Base surface hardened and ground
- Ratchet thimble
- Locking clamp
- Rod diameter: 0.176"
- Includes fitted case

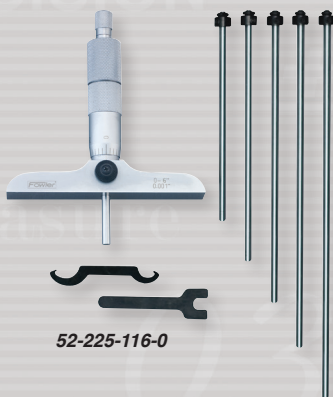

52-225-116-0

Order No.	Range	Graduation	Accuracy	Base Size	List Price	Sale Price
52-225-110-0	0 - 4"	0.001"	0.0002"	2.5"	\$153.23	\$135.00
52-225-112-0	0 - 6"	0.001"	0.0002"	2.5"	\$180.95	\$160.00
52-225-114-0	0 - 4"	0.001"	0.0002"	4"	\$165.55	\$140.00
52-225-116-0	0 - 6"	0.001"	0.0002"	4"	\$193.71	\$165.00

IP54 Electronic Depth Micrometer



Features:

- IP54 protected against fluid and dust
- Range: 0 - 6"/150 mm
- Resolution: 0.00005"/0.001mm
- Hardened tool steel base
- Precision ground and microlapped
- Rod diameter: 0.176"
- Automatic switch off
- Large LCD display
- Includes fitted case



Order No. 54-225-456-0

Sale \$210.00

List \$257.40

Digit Counter Depth Micrometers

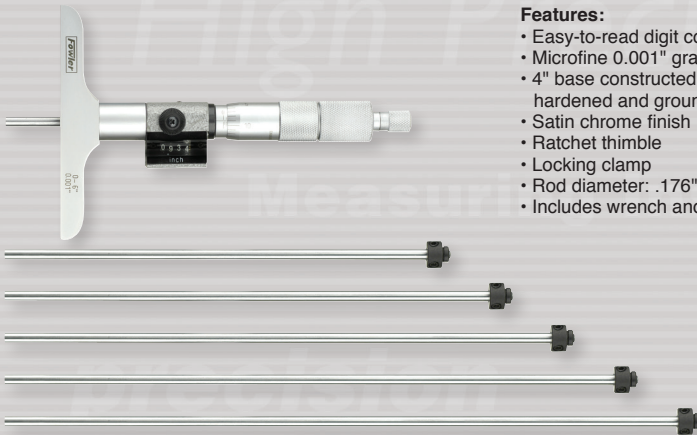

Features:

- Easy-to-read digit counter
- Microfine 0.001" graduations
- 4" base constructed of tool steel, hardened and ground
- Satin chrome finish
- Ratchet thimble
- Locking clamp
- Rod diameter: .176"
- Includes wrench and fitted case

52-225-226-0

Order No.	Range	Graduation	Base	List Price	Sale Price
52-225-176-0	0 - 6"	0.001"	2.5"	\$225.24	\$199.00
52-225-226-0	0 - 6"	0.001"	4"	\$250.24	\$208.00

Inside Micrometers

For measuring tubes, countersinks, bearings, slots and more!



52-275-001-1

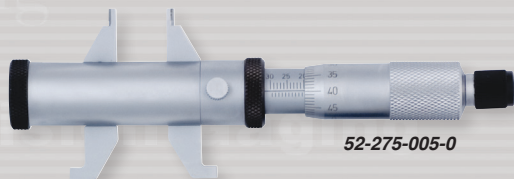

52-275-005-0

Features:

- Measuring faces are fully hardened and precision ground
- Microlapped finished to assure exceptionally accurate readings
- Spindle threads are hardened and ground
- Microfine graduations 0.001" on a satin chrome finish permit easy reading
- Ratchet stop thimble assures exact and repetitive readings
- Includes a setting ring

Order No.	Range	Graduation	Accuracy	List Price	Sale Price
52-275-001-1	0.2" - 1.2"	0.001"	0.0002"	\$128.92	\$108.00
52-275-002-1	1" - 2"	0.001"	0.00024"	138.82	\$118.00

XTRA-RANGE[®] Inside Micrometer

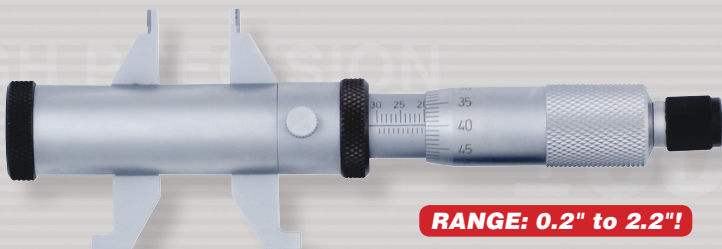

RANGE: 0.2" to 2.2"!

Features:

- Satin chrome finish on barrel and thimble
- Microfine graduations (0.001") on a satin chrome finish permits easy reading
- Accuracy: ± 0.0002 "
- Ratchet stop thimble
- Easy zero adjustment on the sleeve
- Includes a calibration setting ring



Order No. 52-275-005-0

Sale \$180.00

List \$225.41

Electronic IP54 Inside Micrometers



Features:

- IP54 protected against fluid and dust
- Each gage includes appropriate setting ring for exceptional accuracy
- Resolution: 0.00005"/0.001mm
- Large easy-to-read LCD display
- Friction thimble
- Includes fitted case



Includes setting ring!

Order No.	Range	Accuracy	List Price	Sale Price
54-860-275-0	0.2 - 1.2"	0.00020"/0.005mm	\$273.58	\$170.00
54-860-276-0	1 - 2"	0.00024"/0.006mm	\$295.46	\$185.00

Inside Micrometers

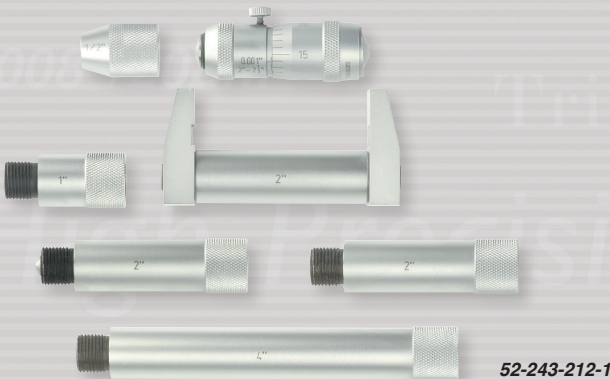

52-243-212-1

Features:

- Each set consists of an inside micrometer head and a series of fully hardened and lapped extension rods of different lengths all with carbide measuring faces
- Anvil and spindle are hardened and precision ground with microlap finish on ends
- Microfine graduations on satin chrome
- Positive locking nut on spindle
- Coiled spring pressure contact type rods are each marked with appropriate length
- Quick, easy zero adjustment on the sleeve
- Accuracy: 0.00005" x (3 + L"/2)
- Graduation: 0.001"
- Includes a wrench, case and reference standard

Order No.	Range	List Price	Sale Price
52-243-026-1	2 - 6"	\$158.51	\$142.66
52-243-212-1	2 - 12"	Compare to Mitutoyo 139-201 @ \$226.13	\$186.54
52-243-220-1	2 - 20"	\$259.48	\$233.53
52-243-260-1	2 - 60"	\$1,341.35	\$1,207.22
52-243-480-1	4 - 80"	\$1,859.26	\$1,673.33
52-243-512-1	4 - 120"	\$3,155.42	\$2,839.88



Fowler Bowers **BLUETOOTH**

Fastest, most consistent hole measurement available world wide!



Pistol grip design significantly decreases measuring time

Measure cylinder bores, high accuracy bearings, grooves, threads and much more!



Traditional style ratchet stop thimble

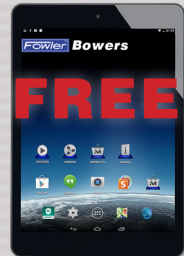

TABLET!

with Complete Set Purchase!



Both styles feature:

- IP67 protected against fluid and dust
- Resolution: 0.00005"/0.001mm
- Bluetooth connectivity to your phone or tablet
- Self centering 3 point heads above 0.250"
- Tungsten carbide measuring faces on all 3-point heads from 0.5"/12.5mm and up
- Sizes over 0.500"/12.5mm feature blind bore capability
- Includes UKAS certificates for all pistol grip, heads and rings

See it in ACTION!



Bore Gaging Systems

21.1

Special Applications puts Fowler above the rest!

Contact the Fowler Technical Department 1-800-788-2353



Bore Gaging



Order No.	Range	Includes	List Price	Sale Price
Pistol Grip Sets				
54-567-009-BT	0.080" - 0.250"/2 - 6mm (2-point heads)	5 heads, 1 handle, 3 rings	\$6,322.70	\$5,374.30
54-567-010-BT	0.250" - 0.375"/6 - 10mm	2 heads, 1 handle, 1 ring	\$2,479.20	\$2,107.40
54-567-020-BT	0.375" - 0.750"/10 - 20mm	3 heads, 1 handle, 2 rings	\$2,900.40	\$2,465.40
54-567-050-BT	0.750" - 2" /20 - 50mm	3 heads, 1 handle, 2 rings	\$3,745.00	\$3,183.30
54-567-100-BT	2" - 4"/50 - 100mm	3 heads, 1 handle, 2 rings	\$4,168.40	\$3,543.20
54-567-105-BT	4" - 6"/100 - 150mm	2 heads, 1 handle, 1 ring	\$3,745.00	\$3,183.30
54-567-110-BT	6" - 8" /150 - 200mm	2 heads, 1 handle, 1 ring	\$4,943.30	\$4,201.90
54-567-200-BT	4" - 8" /100 - 200mm	4 heads, 1 handle, 2 rings	\$7,824.30	\$6,650.70
54-567-210-BT	0.750" - 4"/20 - 100mm	6 heads, 1 handle, 4 rings	\$6,094.40	\$5,180.30
54-567-620-BT	0.250" - 0.750"/6 - 20mm	5 heads, 1 handle, 3 rings	\$3,456.70	\$2,938.20
Holemike Sets (Traditional style)				
54-367-000-BT	0.080" - 0.250"/2 - 6mm (2-point heads)	5 heads, 1 handle, 3 rings	\$5,762.20	\$4,897.90
54-367-010-BT	0.250" - 0.375"/6 - 10mm	2 heads, 1 handle, 1 ring	\$2,400.90	\$2,040.80
54-367-020-BT	0.375" - 0.750"/10 - 20mm	3 heads, 1 handle, 2 rings	\$2,865.00	\$2,435.30
54-367-050-BT	0.750" - 2" /20 - 50mm	3 heads, 1 handle, 2 rings	\$3,890.80	\$3,307.20
54-367-100-BT	2" - 4"/50 - 100mm	3 heads, 1 handle, 2 rings	\$4,307.70	\$3,661.60
54-367-105-BT	4" - 6"/100 - 150mm	2 heads, 1 handle, 1 ring	\$3,636.70	\$3,091.20
54-367-110-BT	6" - 8" /150 - 200mm	2 heads, 1 handle, 1 ring	\$4,803.90	\$4,083.40
54-367-200-BT	4" - 8" /100 - 200mm	4 heads, 1 handle, 2 rings	\$7,590.70	\$6,452.10
Connectivity Cables/Accessory				
54-115-526-0	Proximity cable with USB connection		\$198.87	\$135.00
54-115-527-0	Proximity cable with serial connection		\$202.69	\$135.00
54-115-246-BT	USB bluetooth receiver		\$50.80	\$45.80

Prices & Specifications are subject to change without notice.



Fowler Bowers XT-Series Holemikes

The Fowler Bowers range of mechanical two and three point bore micrometers are now available as XT extended travel holemikes, allowing a wide measurement range without the need to interchange anvils.



52-255-316-0

Features:

- 3-pt contact with tungsten carbide measuring anvils above 0.5"
- Blind bore measuring heads featured above 0.5"
- Ratchet stop for consistent measuring
- Extensions available for deep measuring
- Includes UKAS certificates for all Holemikes and setting rings



BOWERS GROUP



Order No.	Range	Grads.	Meas. Accuracy	Ring Depth	Ring Included	List Price	Sale Price
52-255-310-0	0.250" - 0.312"	0.00025"	0.00015"	2.28"	0.312"	\$745.30	\$596.24
52-255-311-0	0.312" - 0.375"	0.00025"	0.00015"	2.28"	0.312"	\$690.10	\$552.08
52-255-312-0	0.375" - 0.500"	0.00025"	0.00015"	2.28"	0.5"	\$690.10	\$552.08
52-255-313-0	0.500" - 0.625"	0.00025"	0.00015"	2.44"	0.5"	\$690.10	\$552.08
52-255-314-0	0.625" - 0.750"	0.00025"	0.00015"	2.44"	0.75"	\$707.70	\$566.16
52-255-315-0	0.750" - 1"	0.00025"	0.00015"	2.60"	0.75"	\$777.20	\$621.76
52-255-316-0	1" - 1.375"	0.00025"	0.00015"	2.60"	1.375"	\$1,107.40	\$885.92
52-255-317-0	1.375" - 2"	0.00025"	0.00015"	3.15"	1.375"	\$1,133.80	\$907.04
52-255-318-0	2" - 2.625"	0.00025"	0.0002"	3.15"	2.625"	\$1,352.50	\$1,082.00
52-255-319-0	2.625" - 3.250"	0.00025"	0.0002"	3.15"	2.625"	\$1,364.60	\$1,091.68
52-255-320-0	3.250" - 4"	0.00025"	0.0002"	3.94"	3.25"	\$1,702.40	\$1,361.92
Sets							
52-255-565-0	0.250" - 0.375" 2 heads, 2 handles, 1 ring					\$1,654.90	\$1,323.92
52-255-665-0	0.375" - 0.750" 3 heads, 3 handles, 2 rings					\$1,884.50	\$1,507.60
52-255-775-0	0.750" - 2" 3 heads, 3 handles, 2 rings					\$2,961.00	\$2,368.80
52-255-885-0	2" - 4" 3 heads, 3 handles, 2 rings					\$4,014.10	\$3,211.28

Bore Gage Setting Master Kits - Inch & Metric

Fowler's Bore Gage Setting Master Kit is used for accurately setting any bore gage up to 6"/150mm in diameter to an accuracy of 0.0001"/0.003mm



Each Set includes: Setting Device

- Base anvil: 3.950" x 1.050"
- Adjustable anvil 2.375" x .375" (two each)
- Internal capacity: 6"/150mm
- Centralizer capacity width: 2.750"
- Quick-release holder for fast adjustment

Economy Gage Block Sets

Inch model:

- 36 piece
- Tolerances to .00005"
- Certificate of Calibration to NIST

Metric model:

- 33 piece
- AS-2 grade
- Certificate of Calibration to NIST

Bore gage shown not included

Includes:
Bore gage setting master and gage block set!
All in a custom-fitted case!

SCAN For
More Info



Order No.	Description	List Price	Sale Price
53-646-000-1	Inch Bore Gage Setting Master Kit	\$411.69	\$315.00
53-646-010-0	Metric Bore Gage Setting Master Kit	\$365.53	\$292.42
53-646-005-0	Bore Gage Setting Master Kit - <i>without</i> Gage Blocks	\$254.47	\$180.00



Electronic Bore Gage Set with Carbide Anvils

Industry's two most popular bore gage ranges combined in one easy-to-use electronic set! Preset size of master for absolute reading and use minimum hold feature to lock on the bore size as the gage is rocked in the part to be measured.

Bore Gage features:

- Range: 1.4 - 6" / 35 - 150mm
- Resolution: 0.00005"/0.001mm
- Carbide anvils
- Self-centering

Indicator features:

- Bar graph and numeric digital display
- Preset with recall
- ABS/INC measurement
- Min/Max/TIR



"Excellent quality,
well built."
Lee C.



Learn more at
YouTube
FowlerVid



Order No. 54-646-401-0

Sale \$309.¹⁰

List \$377.74

Dial Bore Gage Sets with Carbide Anvils

Features:

- Carbide Anvils
- Easy-to-read
- Economical
- Graduation: 0.0005" or 0.01mm
- Insulated grip
- 9.5" depth
- Chrome plated handle
- Includes fitted case



52-646-400-0



52-646-100-0



Order No.	Range	Graduation	List Price	Sale Price
52-646-100-0	0.7 - 1.5"	0.0005"	\$174.02	\$142.40
52-646-300-0	2 - 6"	0.0005"	\$143.88	\$117.80
52-646-400-0	1.4 - 6"	0.0005"	Compare to Mitutoyo 511-753 @ \$338.25	\$179.00

Prices & Specifications are subject to change without notice.

Internal & External Electronic Caliper Gages



54-554-611-0



54-554-711-0

Features:

- Accuracy: $\pm 0.0008''/\pm 0.02\text{mm}$
- Resolution: $0.0002''/0.005\text{mm}$
- Rugged housing
- Large, LCD display
- Preset capability
- Absolute/Incremental measurements
- High-impact, aircraft aluminum case

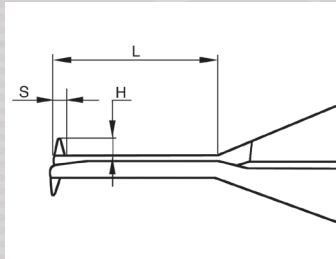

Dimensions for Internal Calipers						
Metric	Inch	L	S	H	Tip Radius	
5-15mm	0.2-0.6"	20mm	1.0mm	1.5mm	0.3mm	
5-25mm	0.2-1.0"	35mm	1mm	1.5mm	0.3mm	
10-30mm	0.4-1.2"	55mm	2mm	3.5mm	0.5mm	
20-40mm	0.8-1.6"	80mm	3mm	6.5mm	0.5mm	
30-50mm	1.2-2.0"	80mm	3mm	8.5mm	0.5mm	

Dimensions for External Calipers						
Metric	Inch	L	S	H	Tip Radius	
0-10mm	0-0.4"	40mm	3mm	8mm	0.5mm	
0-20mm	0-0.8"	80mm	6.5mm	25mm	0.75mm	
10-30mm	0.4-1.2"	80mm	6.5mm	25mm	0.75mm	
20-40mm	0.8-1.6"	80mm	6.5mm	25mm	0.75mm	
30-50mm	1.2-2.0"	80mm	6.5mm	25mm	0.75mm	

Order No.	Range	List Price	Sale Price
Internal Caliper Gages			
54-554-611-0	0.200" - 0.590"/5 - 15mm	\$213.18	\$180.00
54-554-622-0	0.200" - 1 1/5" - 25mm	\$228.58	\$195.00
54-554-623-0	0.400" - 1.2"/10 - 30mm	\$239.25	\$205.00
54-554-624-0	0.790" - 1.6"/20 - 40mm	\$239.25	\$205.00
54-554-625-0	1.2" - 2"/30 - 50mm	\$239.25	\$205.00
External Caliper Gages			
54-554-711-0	0 - 0.400"/0 - 10mm	\$213.18	\$180.00
54-554-722-0	0 - 0.790"/0 - 20mm	\$228.58	\$195.00
54-554-723-0	0.4" - 1.2"/10 - 30mm	\$239.25	\$205.00
54-554-724-0	0.790" - 1.6"/20 - 40mm	\$239.25	\$205.00
54-554-725-0	1.2" - 2"/30 - 50mm	\$239.25	\$205.00

XTRA-VALUE Internal & External Electronic Caliper Gages



54-554-630-0



54-554-730-0

INCH • METRIC • FRACTION™

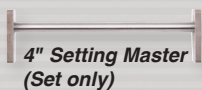

Features:

- Accuracy: $0.01''/0.3\text{mm}/1/64\text{ths}$
- Reading: $0.01''/0.1\text{mm}/1/64\text{ths}$
- Robust housing
- Large LCD display
- Battery: CR2032
- Spring loaded with locking nut

Order No.	Description	Range	List Price	Sale Price
54-554-630-0	Outside Caliper Gage	0 - 6"/0 - 150mm	\$58.19	\$47.00
54-554-730-0	Inside Caliper Gage	0.5 - 6"/12.7 - 150mm	\$58.19	\$47.00
Set				
54-554-650-0	Inside/Outside Caliper Gage Set includes 4" internal setting master		\$104.12	\$84.00



Electronic Divider

Features:

- Range: 0 - 8"/200mm
- Accuracy: 0.001"
- Robust housing
- Large LCD display
- Reading: 0.01"/.1mm/1/64ths
- Satin chrome finish
- Alloy jaws
- Includes metal scribe and graphite attachments

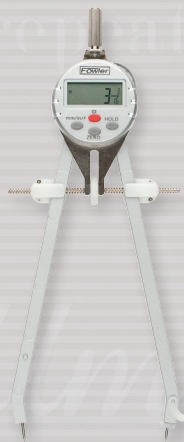

Order No. 54-554-930-0

Sale \$78.⁸⁵

List \$98.56

XTRA-VALUE Digital Thickness Gage

INCH • METRIC • FRACTION

Features:

- Range: 0 - 1"/25mm
- Accuracy: 0.004"
- Robust housing
- Large LCD display
- Reading: 0.001"/0.01mm/1/64ths
- Includes 1/8" ball contact, taper point and a long-stem point
- Battery: CR2032
- Three interchangeable points
- Batter life: approximately 1 year



Order No. 54-554-830-0

Sale \$53.⁰⁰

List \$65.56

Snap-Cal

Fowler's Inch, Metric & Fraction reading Snap Caliper is ideal for measuring a wide range of materials from metal, plastics and glass to small wires, fibers and paper.

Features:

- Range: 0 - 1.25"/31.5mm
- Accuracy: $\pm 0.001"/0.02\text{mm}$
- Resolution: 0.0005"/0.01mm
(Fractions in 1/64th increments)
- Spring-loaded travel
- Wide faced flat jaw for easy positioning
- Dimensions of fixed jaw: 0.470" x 0.900"
- Hardened stainless steel construction
- Direct inch/metric/fraction conversion
- Hanging loop included for attachment to belt or chain



INCH • METRIC • FRACTION

Order No. 54-550-300-1

Sale \$105.⁰⁰

List \$125.07

IP67 **PLUS+** *Electronic Calipers* with Smart Wireless Communication

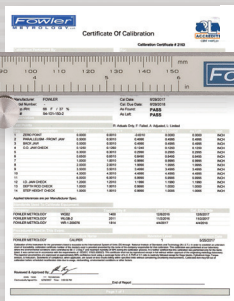

54-100-556-BT

Features:

- **NEW** HID Interface allows connection to most smart phones and tablets
- Wireless connectivity for quick error free data collection
- IP67 protected against fluid and dust
- Includes an extra battery tray and a 1" setting standard
- Supplied with NIST certification
- Heavy duty frame with 4-way measuring, inside, outside, depth and step
- Super large display
- Includes fitted case



Order No.	Range	Accuracy	List Price	Sale Price
54-100-554-BT	0 - 4"/100mm	0.001"/0.02mm	Compare to Mitutoyo 500-762-20 @ \$237.59	\$145.50
54-100-556-BT	0 - 6"/150mm	0.001"/0.02mm	\$205.59	\$149.60
54-100-558-BT	0 - 8"/200mm	0.0015"/0.04mm	\$250.03	\$195.00
54-100-512-BT	0 - 12"/300mm	0.0015"/0.04mm	\$266.64	\$215.00

EURO-CAL IV[®] *Electronic Calipers*

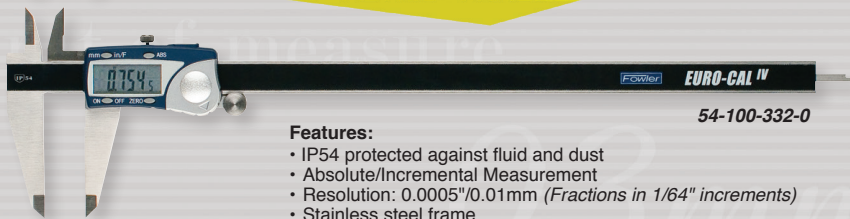

54-100-330-1

INCH • METRIC • FRACTIONTM

54-100-332-0

Features:

- IP54 protected against fluid and dust
- Absolute/Incremental Measurement
- Resolution: 0.0005"/0.01mm (*Fractions in 1/64" increments*)
- Stainless steel frame
- 4-way measuring, inside, outside, depth and step
- Includes fitted case

Order No.	Range	Accuracy	List Price	Sale Price
54-100-330-1	6"/150mm	± 0.001"/0.02mm	\$146.96	\$120.00
54-100-331-0	8"/200mm	± 0.001"/0.02mm	\$173.91	\$126.50
54-100-332-0	12"/300mm	± 0.0015"/0.03mm	\$223.08	\$182.60

Water Resistant IP54 Electronic Calipers

Absolute Reading!



54-100-777-2

Features:

- IP54 protected against fluid and dust
- Absolute/Incremental Measurement
- Resolution: 0.0005"/0.01mm
- 4-way measuring, inside, outside, depth and step
- Stainless steel frame
- Wireless SPC data option
- Includes fitted case



Order No.	Range	Accuracy	List Price	Sale Price
54-100-777-2	0 - 6"/150mm	0.0015"/0.04mm	\$161.70	\$132.30
54-100-712-2	0 - 12"/300mm	0.0015"/0.04mm	\$235.18	\$171.10
Accessory				
54-115-100-0	Wireless Transmitter		\$123.09	\$100.00

Digital Calipers

Absolute Reading!



54-100-000-2

Features:

- Resolution: 0.0005"/0.01mm
- Absolute/Incremental Measurement
- Stainless steel frame
- Direct Inch/Metric conversion
- 4-way measuring, inside, outside, depth and step
- Wireless SPC data option
- Includes fitted case

Order No.	Range	Accuracy	List Price	Sale Price
54-100-000-2	0 - 6"/150mm	0.001"/0.02mm	<i>Compare to Mitutoyo 500-196-30 @ \$141.40</i>	\$117.90
54-100-008-2	0 - 8"/200mm	0.0015"/0.04mm	\$169.07	\$138.40
54-100-112-2	0 - 12"/300mm	0.0015"/0.04mm	\$220.44	\$180.40
Accessories				
54-115-100-0	Wireless transmitter		\$123.09	\$100.00
54-520-399-0	SPC cable (USB)		\$211.98	\$137.60



XTRA-VALUE CAL Electronic Calipers

Buy a 12" Get a 6" FREE

Buy a 12" (54-101-300-1) at **list price** and get a 6" (54-101-150-2) **FREE**



Features:

- Accuracy: 0.001"/0.02mm (6" models)
- Stainless steel frame
- Large easy-to-read display
- Resolution: 0.0005"/0.01mm
- Absolute/Incremental Measurement
- 4-way measuring, inside, outside, depth and step
- Includes fitted case



Order No.	Range	Display Type	List Price	Sale Price
54-101-300-P	Buy a 12" (54-101-300-1) and Get a 6" (54-101-150-2)	FREE	\$169.07	\$112.64
54-101-150-2	6"/150mm	Regular Display - includes FREE NIST Cert.	\$56.43	\$46.20
54-101-600-1	6"/150mm	Super Large Display with hold feature	\$73.59	\$60.30
54-101-800-1	8"/200mm	Super Large Display with hold feature	\$110.22	\$90.20
54-101-300-1	12"/300mm	Regular Display - includes FREE NIST Cert.	\$112.64	\$92.20
54-101-900-1	12"/300mm	Super Large Display with hold feature	\$147.18	\$120.50

XTRA-VALUE Plus Electronic Calipers



Features:

- IP54 protected against fluid and dust making it **great for shop environments**
- Resolution: 0.0005"/0.01mm
- Inch/Metric/Fraction reading: 0.0005"/0.01mm/ 1/128"
- Heavy Duty frame for extra rigidity and wear resistance
- Super large, easy to read 14 x 52mm display
- Combined thumbrest and thumbroll for fine adjustment
- Includes fitted case



Order No.	Range	Accuracy	List Price	Sale Price
54-103-006-0	6"/150mm	± 0.001"/0.02mm	\$88.00	\$80.00
54-103-012-0	12"/200mm	± 0.0015"/0.03mm	\$150.04	\$124.00

Machinist Grade Dial Calipers

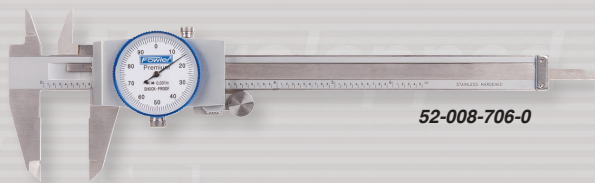

52-008-706-0

“Very precise with consistent readings. I would never change this analog for a digital one”
Erick T.



52-008-707-0

Features:

- 4-way measuring, inside, outside, depth and step
- Solid stainless steel construction
- 0.100"/2mm range per revolution
- 0.001"/0.02mm reading dial face
- Tough shockproof gearing
- Includes fitted case



Order No.	Range	Dial Face Color	Accuracy	List Price	Sale Price
52-008-706-0	0 - 6"	White	± 0.001"	\$95.00	\$83.00
52-008-707-0	0 - 6"	Black	± 0.001"	\$95.00	\$83.00
52-008-712-0	0 - 12"	White	± 0.002"	Compare to Mitutoyo 505-746 @ \$230.00	\$119.90

0 - 6" Dial Calipers

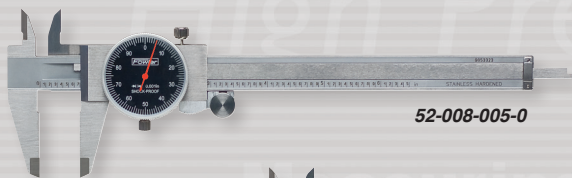

52-008-005-0

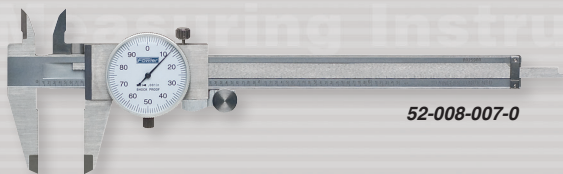

52-008-007-0

Features:

- 4-way measuring, inside, outside, depth and step
- Covered rack
- Accuracy ± 0.001"
- 0.100" per revolution
- Dial graduation: 0.001"
- Hardened stainless steel rack
- Includes fitted case

Order No.	Range	Dial Face Color	Accuracy	List Price	Sale Price
52-008-005-0	0 - 6"/150mm	Black	± 0.001"	\$103.73	\$78.90
52-008-007-0	0 - 6"/150mm	White	± 0.001"	\$103.73	\$78.90



INDI-X^{blue}[®]

Electronic Indicators

Features:

- Accuracy: $\pm 0.001"/0.03\text{mm}$
- Resolution 0.0005"/0.01mm
- 2-1/4" dial face
- Lugback and 3/8" stem mountings
- Tolerance function
- Absolute/incremental reading
- Floating zero



INCH • METRIC • FRACTION™



54-520-255-0

"Easy to use, easy to read, top notch accuracy"

Mr. R.



54-520-260-0



Order No.	Range	List Price	Sale Price
54-520-255-0	0.50"/12.5mm	Compare to Mitutoyo 543-783 @ \$153.79	\$91.70
54-520-250-0	1"/25mm	\$123.31	\$105.00
54-520-260-0	1"/25mm/64ths	\$125.18	\$102.50

Depth Base Attachments

Features:

- Turn your dial or electronic indicator into a depth gage
- 4" length for accuracy
- Fits indicators with 3/8" and 8mm mounting stems
- Ground and lapped base
- Each supplied with 4 extension points, for added application range (4 - 48 thread)
- 52-125-005-0 has 0.430" radius



52-125-004-0

Order No.	Description	List Price	Sale Price
52-125-004-0	Flat depth base attachment	\$45.43	\$37.20
52-125-005-0	Radius style depth base attachment	\$45.43	\$37.20

Indicator Contact Point Set

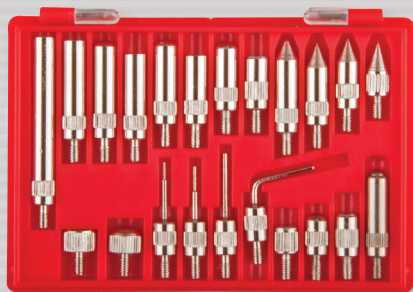

Features:

- 22 piece set
- 4-48 thread
- Works with AGD style indicators
- Supplied in fitted case

Order No. 52-525-222-0

Sale \$34.⁷⁶

List \$43.45

INDI-X^{blue}

IP65 HIGH Resolution Electronic Indicator

Features:

- IP65 protected against fluid and dust making it *great for shop environments*
- Range: 1"/25mm
- Accuracy: $\pm 0.0002"/0.005\text{mm}$
- Resolution: $0.00005"/0.001\text{mm}$
- Carbide tip
- Tolerance function
- Contains flat and center lug backs
- Includes NIST certification and fitted case

Order No. 54-520-270-0

Sale \$135.⁰⁸

List \$168.85



INDI-X^{blue}

IP65 Electronic Indicator

Features:

- Range: 1"/25mm
- Accuracy: $\pm 0.0012"/0.03\text{mm}$
- Resolution: $0.0005"/0.01\text{mm}$
- IP65 protected against fluid and dust
- Carbide tip
- Tolerance function
- Contains flat and center backs
- Includes NIST certification and fitted case

Order No. 54-520-265-0

Sale \$112.⁸²

List \$141.02



INDI-X^{blue}

Small Face Electronic Indicator

Features:

- Range: 0 - 0.50"/0 - 12.5mm
- Accuracy: $\pm 0.0008"/0.02\text{mm}$
- Resolution: $0.0005"/0.01\text{mm}$
- 1.76" dial face
- Carbide tip
- Contains flat and center lug backs
- Includes NIST certification and fitted case

Order No. 54-520-275-0

Sale \$101.⁷³

List \$127.16



21.1

Indicators & Bases

Fowler®

Premium Dial Indicators

Features:

- Tolerance markers
- Solid steel housing
- Carbide contact point



52-520-105-0

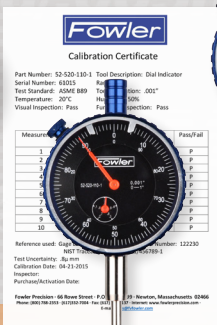

52-520-110-1



52-520-110-2

"Great price for a great indicator" V.C.



Includes NIST Certificate of Calibration

Order No.	Range	Graduation	Reading	Balanced Reading	Dial Color	List Price	Sale Price
52-520-110-1	1"	0.001"	0 - 100	—	Black	Compare to Mitutoyo 2904S @ \$115.95	\$82.63
52-520-110-2	1"	0.001"	0 - 100	—	White	Compare to Mitutoyo 2904S @ \$115.95	\$82.63
52-520-105-0	0.50"	0.001"	0 - 100	0 - 50 - 0	White	\$97.68	\$78.14
52-520-115-0	1"	0.001"	—	0 - 50 - 0	White	\$112.30	\$89.84
52-520-125-0	0.250"	0.0005"	0 - 50	0 - 25 - 0	White	\$136.29	\$109.03
52-520-129-0	1"	0.0005"	0 - 50	0 - 25 - 0	White	\$124.85	\$99.88
52-520-300-0	10mm	0.01mm	0 - 100	0 - 50 - 0	White	\$117.92	\$94.34
52-520-500-0	25mm	0.01mm	0 - 100	0 - 50 - 0	White	\$157.19	\$125.75

Premium IP54 Shockproof Dial Indicators

Features:

- Includes NIST Certification
- Includes both center lug back and flat back
- Steel housing
- Sealed plunger, dust-cap and back plate
- Carbide contact point
- 0 - 100 dial reading with rev. counter



52-520-460-0

52-520-465-0

Order No.	Range	Graduation	Reading	Contact Point	List Price	Sale Price
52-520-460-0	1"	0.001"	0 - 100	4 - 48 (3/8" stem)	\$112.09	\$99.00
52-520-465-0	1"	0.001"	0 - 100	4 - 48 (3/8" stem)	\$112.09	\$99.00

X-TEST[®] Horizontal Indicators

NOW available with High Contrast Dial Face!

Features:

- Solid brass anti-magnetic housing
- Super smooth jeweled movement
- Smooth bezel adjustment for easy zero setting
- 0.080" and 0.120" carbide ball contact points (0.040" steel ball)
- 0.060" range with auto reverse and rev. counter
- Easy to read tilted dial
- 5/32" pivotable stem



52-562-002-BD

Includes NIST Certificate of Calibration

Order No.	Graduation	Dial Size	Dial Reading	List Price	Sale Price
52-562-001-BD	0.0005"	1-1/2"	0 - 15 - 0	Compare to Brown & Sharpe 74.111370 @ \$229.01	\$120.40
52-562-002-BD	0.0005"	1"	0 - 15 - 0	\$147.07	\$120.40

XTEST[®] Horizontal Indicators

Features:

- Solid brass anti-magnetic housing
- Super smooth jeweled movement
- Smooth bezel adjustment for easy zero setting
- 0.080" and 0.120" carbide ball contact points (0.040" steel ball)
- 0.060" range with auto reverse and rev. counter
- Easy to read tilted dial
- 5/32" pivotable stem



52-562-001-0

52-562-002-0

Includes NIST Certificate of Calibration

Order No.	Graduations	Dial Diameter	Dial Reading	List Price	Sale Price
52-562-001-0	0.0005"	1-1/2"	0-15-0	Compare to Brown & Sharpe 74.111370 @ \$229.01	\$120.40
52-562-002-0	0.0005"	1"	0-15-0	Compare to Brown & Sharpe 74.111370 @ \$229.01	\$120.40
52-562-003-0	0.001"	1"	0-15-0	\$147.07	\$120.40
52-562-007-0	0.01mm	25mm	0-40-0	\$147.40	\$131.80
52-562-008-0	0.01mm	38mm	0-40-0	\$147.40	\$120.40

XTEST[®] Vertical Indicators

TWICE the range of most indicators!

Features:

- Solid brass anti-magnetic housing
- Smooth bezel adjustment for easy zero setting
- 0.080" and 0.120" carbide ball contact points (0.040" steel ball)
- 0.060" range with auto reverse and rev. counter
- 5/32" pivotable stem



52-562-005-0

Includes NIST Certificate of Calibration

Order No.	Graduations	Dial Diameter	Dial Reading	List Price	Sale Price
52-562-004-0	0.0005"	1-1/2"	0-15-0	\$161.04	\$131.80
52-562-005-0	0.0005"	1"	0-15-0	\$161.04	\$131.80
52-562-006-0	0.001"	1"	0-15-0	\$161.04	\$131.80



Any Indicator on this page \$120.00

Test Indicators

All Fowler Test Indicators include bi-directional constant clockwise rotation, automatic reversal, three dovetail mountings, jeweled movement, two dovetail clamps and a molded case.

0.001"
0.0005"
Reading



Extra Points

.040" .120"

Order No.	Dial Color	Total Range	Dial Reading	Graduation	Dial Diameter	Point Length	List Price
52-562-774-0	white	0.030"	0-15-0	0.001"	1"	1/2"	\$138.27
52-562-778-0	black	0.030"	0-15-0	0.0005"	1"	1/2"	\$146.96
52-562-775-0	white	0.030"	0-15-0	0.0005"	1"	1/2"	\$146.96
52-562-776-0	white	0.030"	0-15-0	0.0005"	1-1/2"	1/2"	\$153.67
52-562-780-0	black	0.030"	0-15-0	0.0005"	1-1/2"	1/2"	\$153.67

0.0001"
Reading



Extra Points

.040" .120"

Order No.	Dial Color	Total Range	Dial Reading	Graduation	Dial Diameter	Point Length	List Price
52-563-771-0	black	0.008"	0-4-0	0.0001"	1"	1/2"	\$146.96
52-563-772-0	black	0.008"	0-4-0	0.0001"	1-1/2"	1/2"	\$146.96
52-563-777-0	white	0.008"	0-4-0	0.0001"	1-1/2"	1/2"	\$146.96

Extra
Long
Contact



Extra Points

.040" .120"

Order No.	Dial Color	Total Range	Dial Reading	Graduation	Dial Diameter	Point Length	List Price
52-562-781-0	white	0.020"	0-10-0	0.0005"	1"	1-7/16"	\$151.36
52-562-782-0	black	0.020"	0-10-0	0.0005"	1"	1-7/16"	\$151.36
52-562-783-0	white	0.020"	0-10-0	0.0005"	1-1/2"	1-7/16"	\$151.36
52-562-784-0	black	0.020"	0-10-0	0.0005"	1-1/2"	1-7/16"	\$151.36

Height Transfer and Squareness Gage

A perfect match for **QuadraTest™** Indicators!

Features:

- Used for a variety of surface plate applications
- Large fine adjustment knob for precise control
- Swivel clamp anchors swivel and indicator for added accuracy
- Rear surface of the gage has a reference surface to place against a master for checking squareness
- Includes a 7.5" post, indicator rod and clamp



Indicator and standard shown not included

Order No. 53-620-010-0

Sale \$200.00

List \$374.88

Granite Dial Gage Stand

Features:

- Sturdy and compact with extreme stability
- 6" x 6" x 2" granite base
- Positive lock screw
- Fine adjustment knob for zero setting
- Column height is 8"
- Accepts all lug-back indicators
- This stand is maintenance free
- Flatness: 0.00005"



Indicator not included with stand

Order No. 52-580-030-0

Sale \$110.00

List \$137.50

Roto Dial Indicator Holder

NEW

360° Application Range!

Features:

- Made in the USA
- Rotates a full 360°
- Infinite adjustments
- Use with a mag base or alone in your machine
- 1", 0.001 graduation indicator
- Fine adjust magnetic base with 85 lb. pull (optional)
- Made from anodized 6061 billet aluminum



52-585-400-0



52-585-411-0



52-585-415-0

Order No.	Description	List Price	Sale Price
52-585-400-0	Roto Dial ONLY	\$178.00	\$169.10
52-585-411-0	Roto Dial with Premium Indicator	\$215.00	\$204.25
52-585-415-0	Roto Dial with Premium Indicator and Fine Adjust Mag Base	\$295.00	\$280.25

Magnetic Bases

Features:

- 9.5" Height and 85 lb. pull
- Base dimensions are 2" x 2-11/32" x 1-13/16"
- Accepts all AGD dial indicators
- V-bottom base allows mounting on cylindrical surfaces
- Mounts test indicators with 1/4" post mount

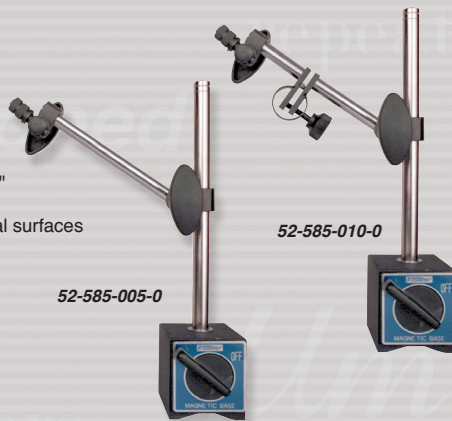

52-585-005-0

52-585-010-0

Order No.	Description	List Price	Sale Price
52-585-005-0	Magnetic base	\$58.74	\$46.99
52-585-010-0	Magnetic base w/fine adjustment	\$69.08	\$55.26

Flex Arm Magnetic Base

Features:

- All purpose magnetic base with 180 lbs. of pulling power
- Base can be mounted vertically as well as horizontally
- V-bottom base allows mounting on cylindrical surfaces
- Adjusts to virtually any position

Order No. 52-585-015-0

Sale \$72.⁹⁵

List \$91.19



AnyForm Magnetic Base

Features:

- Versatile - 70 steel segments work like a contour gage to fit mag base securely to any shape or form
- Unlock the cam mechanism and magnetic segments will conform to any odd shape
- Rigid one-piece construction with permanent powerful magnet holds securely
- There's no longer any need to make extra fixtures to set indicators
- Unlimited versatility - used with coolant systems, lamps, etc.
- Side arm clamp holds all AGD dial indicators and all test indicators with a 1/4" dia. stem

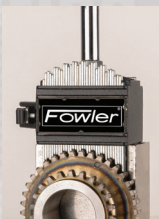

Order No. 52-585-200-0

Sale \$93.⁵⁴

List \$116.92

XTRA-HEIGHT PLUS+

Electronic Height Gage

Measures ID/OD, centerlines, heights, widths, depths, min/max/delta, slots, grooves and more!

NEW



PERFECT for the Work Shop!

Features:

- Easy-to-use
- Range: 16"/407mm
- Repeatability: 0.00012"/0.003mm
- Resolution: 0.00005"/0.001mm
- Single probe holder
- Fixed measuring force 7.5N
- High contrast display
- Includes standard 4mm \varnothing ruby tipped probe, setting gage, AC adapter
- Accessory probes available



FREE Right Angle Depth Probe!

Order No. 54-190-002-0

Sale \$3,999.⁰⁰

List \$4,150.00

XTRA-MAG Height **PLUS+**

Electronic Height Gage

Features:

- **NEW** smaller sized, lightweight, aluminum base with embedded magnets allows positioning on machine tools, small fixtures, lathe beds where vibration can be an issue. Even mount it horizontally for unique applications.
- Range: 0 - 6⁷/₁₆ - 150mm
- Accuracy: 0.001"/0.01mm
- Resolution: 0.0005"/0.01mm
- Large, high contrast LCD display
- Direct Inch/Metric conversion
- ABS/INC measurement
- Floating zero
- Hold feature
- Positive carriage lock and fine adjust
- Carbide tipped scriber for measuring and scribing

NEW

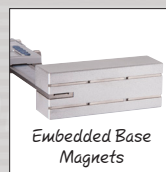

Order No. 54-176-006-0

Sale \$199.⁰⁰

List \$216.70

Twin Beam Electronic Height Gages with Offset Scriber

Features:

- Carriage design with offset scriber holder
- Base is ground and lapped for flatness
- Handwheel provides course and fine movement
- Updated electronic and mechanical design offers better accuracy and movement of carriage
- Carbide tipped scriber
- Functions include preset, in/mm conversion and ABS/INC for direct or comparative measuring

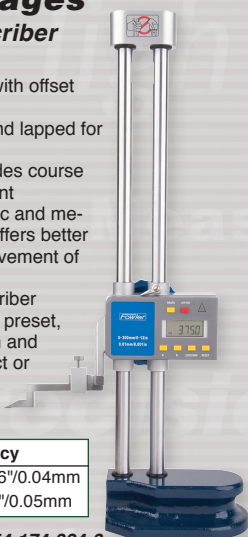

Range	Accuracy
12"	± 0.0016"/0.04mm
24"	± 0.002"/0.05mm

54-174-224-3

Twin Beam Dial Height Gages

- Separate digit counters register both upward & downward travel
- Zero setting can be obtained throughout the gage's range
- Coarse readings in 0.100" graduations: fine readings taken on indicator are 0.001"
- Dual chrome plated beams
- Carbide-tipped scriber.
- Base is hardened, ground & lapped for maximum flatness

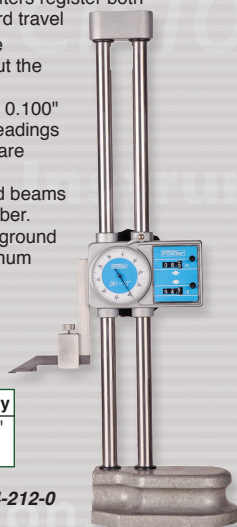

Range	Accuracy
12"	± 0.0015"
24"	± 0.002"

52-174-212-0

Order No.	Range	List Price	Sale Price
54-174-212-3	12"/300mm	\$549.12	\$439.30
54-174-224-3	24"/600mm	\$768.68	\$629.00
Accessory			
54-174-226-0	Contact sensor	\$31.50	\$27.50

Order No.	Range	List Price	Sale Price
52-174-212-0	12"	\$329.45	\$269.60
52-174-224-0	24"	Compare to Mitutoyo 192-152 @ \$1,399.00	\$449.30

Prices & Specifications are subject to change without notice.

Digi Level PLUS+

Features:

- IP65 protected against fluid and dust
- Super large 0.70" backlit display
- Includes a 6" straight edge with beveled edge and 1/32nds graduations
- Smart wireless available to connect to phone or tablet
- V's on top and bottom for measuring on cylindrical surfaces
- Embedded magnets on bottom base for vertical and horizontal hold
- Accuracy: $\pm 0.2^\circ$
- Resolution: 0.050°
- Rechargeable battery
- USB charging cable supplied
- Auto inverting display



54-422-550-0



Vertical Positioning



Horizontal Positioning



Order No.	Description	List Price	Sale Price
54-422-550-0	Digi-Level PLUS	\$139.48	\$120.00
54-422-550-BT	Digi-Level PLUS with smart wireless	\$157.63	\$145.00

mini-MAG PLUS

The Mini-Mag PLUS Protractor features a USB rechargeable battery, a backlit display, Tilt% function

Features:

- IP54 protected against fluid and dust
- Auto off after 5 minutes
- Embedded magnets
- Display automatically inverts
- Smaller size: 2.12" x 2.12" x .9"
- Measuring range: 360° (4 x 90)
- Accuracy: $\pm 0.2^\circ$
- Resolution: 0.05°
- Hold feature
- Zero function



Order No. 54-422-500-0

Sale \$106.00

List \$129.91

mini-MAG Protractor™

The mini-MAG Protractor provides instant 360° digital inclination display of any angle

Features:

- Embedded magnets with 3.5lb. pull
- Display automatically inverts
- Measuring range: 360° (4 x 90°)
- Accuracy: $\pm 0.2^\circ$
- Resolution: 0.05°
- Dimensions: 2.375" x 1.375" x 2.375"
- Hold feature



Display inverts for easy reading!



54-422-460-0

- On/off, tilt %, light, zero functions
- Display is backlit for low light areas



54-422-450-1



Order No.	Description	List Price	Sale Price
54-422-450-1	mini-MAG protractor	\$117.48	\$95.00
54-422-460-0	mini-MAG II protractor	\$123.53	\$100.00

Combination Squares



52-370-012-0

Features:

- Blades are chrome plated, fully hardened and tempered
- 4 piece includes: square, protractor and center heads with 12" blade
- 2 piece includes: square head and 12" blade
- Square head has level and scriber point
- Double indexed protractor is graduated 180° in both directions
- Graduated in 8ths, 16ths, 32nds and 64ths

Order No.	Description	List Price	Sale Price
52-370-012-0	4 piece combination square	\$236.50	\$189.20
52-373-012-0	2 piece combination square	\$152.21	\$121.77

COAX-2D 2 Dimensional Coaxial Indicator Sets

Use the 2D Coaxial Set for accurate component centering and positioning in most machining applications. The dial remains stationary during the rotation of the machine spindle.

- Graduations and revolution counter 0.0005"/0.01mm)
- 3 Internal and 3 External feelers
- Includes center point feeler and straining arm
- Restraining arm

Features:

- Shank: 3/8" dia. x 7/8" (10mm x 20mm) long
- Feeler ball: 1/8" (3mm) dia.
- Measuring range: 0.250" (6mm) axis offset
- Speed recommended not to exceed approx. 800 RPM
- Repeatability to within 0.0002" (0.005mm) of true center
- Capacity depends on feelers installed, but overall range is 5/32-12" / 4-300mm) internal diameter; 0-12" / 0-300mm external diameter



52-710-025-0

Order No.	Description	List Price	Sale Price
52-710-025-0	2D Coaxial Set - Inch	\$281.82	\$230.60
52-710-030-0	2D Coaxial Set - Metric	\$287.32	\$235.00

Electronic Edge Finders

Features:

- Six equally spaced light ports provide visibility at any angle
- Edge finder lights instantly when stylus touches work edge
- Repeatability: 0.0002"
- Works on any conductive metal



54-575-600-0

54-575-625-0

54-575-650-0

Along with light indication, model #54-575-650-0 emits an audible "beep" at time of contact

Order No.	Stylus	Shank	Audible	Battery	List Price	Sale Price
54-575-600-0	0.200"	1/2"	NO	12 volt	\$42.00	\$37.80
54-575-625-0	0.200"	1/2"	NO	12 volt	\$145.00	\$130.50
54-575-650-0	0.400"	3/4"	YES	12 volt	\$145.00	\$130.50

QUICK CHECK

Multi-Function Check Standard



Check

- ✓ Height Gages
- ✓ Micrometers
- ✓ Depth Gages
- ✓ Bore Gages
- ✓ Test & Dial Indicators
- ✓ Caliper Gages
- ✓ Protractors & more

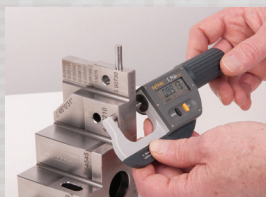

Features:

- Accuracy of indicated values $\pm 0.00012''$
- All sizes marked are actual
- One compact, multi-function, precise standard
- Can be used to check and verify a multitude of measuring instruments
- Supplied with a manufacturer's test certificate and fitted wood case

Order No. 53-813-015-0

Sale \$1,550.⁰⁰

List \$1,877.01

Grade \emptyset Rectangular Steel Gage Block Sets

Features:

- Grade \emptyset
- Certificate of Calibration traceable to N.I.S.T.
- Each block is individually serialized
- Sizes clearly marked on each block
- Complete with fitted wooden case

A better grade for finer work!



53-670-038-0

Order No.	Description	List Price	Sale Price
53-670-038-0	36 piece Grade \emptyset Rectangular Gage Block Set	\$543.62	\$480.00
53-670-080-0	81 piece Grade \emptyset Rectangular Gage Block Set	\$1,000.34	\$800.27

SPACE X-BLOX® PLUS+ Sets



21.1

Pre-sized, solid aluminum.
Common sizes used for
setting heights, drill press
depth stops and fences.



SCAN For
More Info



Available in two combination sets!

Features:

- Accuracy: 0.001" on all sides
- All blocks are 3" long by 1/2" high
- 1-2-3 blocks feature 1/32" graduations on 2" and 3" sides
- Blue anodized finish
- Includes fitted case

Included with sets!



6" Straight Edge PLUS

Useful for layout and alignment applications!

Order No.	Description	List Price
52-439-050-0	Block sizes in matched pairs: 1-2-3 blocks, 3/4", 1/2", 3/8", 1/4", 3/16", 1/8", 1/16"	\$195.00
52-439-055-0	Block sizes (1 each): 1-2-3- block, 3/4", 23/32", 1/2", 15/32", 7/16", 3/8", 5/16", 1/4", 7/32", 3/16", 5/32", 1/8", 3/32", 1/16"	\$195.00



XTRA-TRI® PLUS+ Square Set

Perfect for set up and layout work, measuring and marking angles.
Used for metal working, wood working and fabrication



SCAN For
More Info



Features:

- 4" and 7" squares with embedded magnets for horizontal and vertical position holding
- Carbide tipped scriber

Included with sets!



6" Straight Edge PLUS

Useful for layout and alignment applications!

Order No. 52-432-100-0

Price \$199.⁹⁵

X-BLOX® V-Block Set

2 each @:

- Dimensions: 1-1/2" L x 1-1/4" W x 1-1/4" H
- Work capacity: Approximately 1"

2 each @:

- Dimensions: 2" L x 1-1/2" W x 1-1/2" H
- Work capacity: 1-1/2"

All feature:

- Surfaces are square and parallel within 0.0005"
- V-grooves are square and parallel with all surfaces within 0.0005"
- Corresponding dimensions for each pair are alike within 0.0005"

Order No. 52-475-500-0



"You will not go wrong buying this product"
J.B.

Sale \$124.¹⁰

List \$148.94

Prices & Specifications are subject to change without notice.

51

Shop Tools



Quill Kit

A vertical digital scale designed specifically to display the Z-axis movement of machine tools. Can be mounted on most surfaces enabling precise linear movement. Floating zero and preset functions allow "zero" set anywhere along the travel of the digital readout. Fits most knee mills, drill presses and other machine tools with easy installation.

Features:

- IP54 protected against fluid and dust
- Includes quill installation tool kit
- Range: 0 - 6"/150mm
- Accuracy: $\pm 0.001"/0.03\text{mm}$
- Resolution: $0.0005"/0.01\text{mm}/1/64"$
- Preset, zero, in/mm, absolute/incremental, on/off functions
- Stainless steel construction
- Interchangeable mounting brackets with hardware



Order No. 54-050-100-0

Price \$195.⁰⁰



1-2-3, 2-3-4 & 2-4-6 Blocks

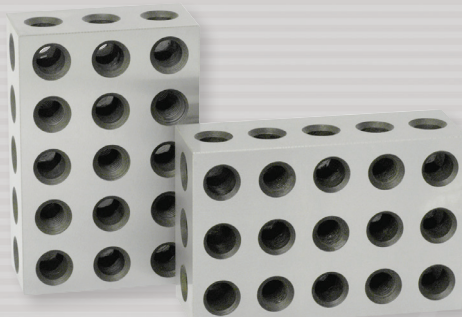

52-439-234-0

Features:

- 23 holes for easy clamping
- Sold in pairs
- Hardened 56 - 60 HRC
- Useful in layout and grinding work

Order No.	Description	Accuracy	List Price	Sale Price
52-439-031-0	1-2-3 Blocks	$\pm 0.0002"/1"$	\$105.82	\$84.66
52-439-234-0	2-3-4 Blocks	$\pm 0.0001"/1"$	\$110.00	\$92.00
52-439-246-0	2-4-6 Blocks	$\pm 0.0003"/1"$	\$249.59	\$199.67

X-PRO™

- Small, compact size
- 2 selectable parameters: Ra and Rz
- Large LCD display
- Meets ISO and DIN standards
- N.I.S.T. traceable specimen included
- Uses 9 volt battery (approx. 3000 measurements)
- Includes fitted case



54-410-500-0



The X-Pro Portable Roughness Tester II can be used for many applications by selecting from a variety of accessories, including:

- Stand with swivel
- A variety of probes

RS232 is available on certain models (contact the Fowler technical department for more information)



(X-Pro shown with optional stand with swivel)

X-Pro Portable Roughness Tester II

Order No.	Description	Sale Price
54-410-500-0	Portable Surface Roughness Tester 0.0004" probe (NIST specifications) <i>Compare to MAHR EMD-1500-311 @ \$2395.00</i>	\$1,666.70
54-410-600-0	Portable Surface Roughness Tester 0.0002" probe (DIN specifications) <i>Compare to MAHR EMD-1500-311 @ \$2395.00</i>	\$1,666.70

X-Pro Portable Roughness Tester II Stand with Swivel

Order No.	Description	List Price	Sale Price
54-400-896-0	Stand with Swivel Attachment	\$490.60	\$475.00

X-Pro Portable Roughness Tester II Probes and Accessories

Order No.	Description	Resolution	List Price	Sale Price
54-400-319-0	General Purpose Probe	0.0004"	\$800.00	\$720.00
54-400-326-0	General Purpose Probe	0.0002"	\$800.00	\$720.00
54-420-321-0	Small Bore Probe	0.0004"	\$885.72	\$778.50
54-420-327-0	Small Bore Probe	0.0002"	\$885.72	\$778.50
54-420-301-0	Traverse Chisel Probe	0.0004"	\$885.72	\$778.50
54-420-302-0	Parallel Chisel Probe	0.0004"	\$885.72	\$778.50
54-420-328-0	Groove Bottom Probe	0.0004"	\$885.72	\$778.50
54-420-120-0	AC Adapter Kit		\$75.02	\$61.40

Prices & Specifications are subject to change without notice.

Tool Presetter

Quick checking of heights and diameters (radius) of all kinds of tools such as ISO, BT, HSK, VDIA etc. is guaranteed by a fixed precise steel measuring column with displacement devices in coordinates (X/Z) and constant measuring force.



Tool Holding Spindle

Tool presetter is supplied with high precision imported ball cage bearing (Grade 0)
High precision spindle has:

- ISO 50 taper
- Less than 2 μm concentricity error



Display

- Min/Max functions for TIR readings
- 2 reference indications
- Preset and Tolerance value inputs
- Radius or diameter indication on X-axis display
- Measuring unit (mm/inch) indication
- Low battery warning indication
- Display hold to retain readings
- Output - OPTO RS232 for each axis
- Floating zero function anywhere within axis range
- Carbide measuring insert for durability
- Accepts measuring probes with 8mm shank

Additional Features

- Counter balanced measuring carriage
- Constant measuring force in both axes
- **High precision Swiss measuring system**

Applications



Height Measurement



Diameter/Radius Measurements



Checking of a Runout

Order No.	Description	List Price	Sale Price
54-188-300-0	Tool Presetter	\$11,096.59	\$9,350.00
54-121-000-0	ISO 50/45 Tool Pot Adapter	\$1,196.43	
54-121-005-0	ISO 50/40 Tool Pot Adapter	\$772.40	
54-121-010-0	ISO 50/35 Tool Pot Adapter	\$1,196.43	
54-121-015-0	ISO 50/30 Tool Pot Adapter	\$963.26	
54-188-333-0	ISO 50 Setting Gage	\$640.00	
54-188-335-0	ISO 40 Setting Gage	\$1,136.10	

Weight & Counting Scale

21.1



Measures up to 66 lbs.!



Shop Tools

Features:

- Accurately measures weights and quantities
- Use for counting large batches of small parts
- Measure weights up to 66lbs/30kg
- Removable stainless steel weighing pan and durable ABS housing
- Converts pounds, ounces, grams, kilograms
- Internal battery with 100 hours of use
- Front panel leveling indicator with adjustable leveling feet
- 3 panel backlit LCD display indicates weight, average piece weight and count

Order No. 54-750-030-0

Price \$170.00

Fowler



HIGH PRECISION
www.fowlerprecision.com

Headquarters

66 Rowe Street • Newton • Massachusetts 02466
(800) 788-2353 • (617) 332-4137 fax
sales@fowlerprecision.com

Distribution Center & Showroom

28010 Industry Drive
Valencia, California 91355
(415) 633-5354

Find us on social media

